

# Energy Management in a Standalone PV System with Priority Controller

Ashok Kumar B<sup>1</sup>, Senthilrani S<sup>2</sup>, Rajeswari J<sup>3</sup>, T.Rajapandi<sup>4</sup>

<sup>1</sup>Thiagarajar College of Engineering, Madurai, India

<sup>2,3</sup>Velammal College of Engineering and Technology, Madurai, India

<sup>4</sup>LathaMathavan Polytechnic College

**ABSTRACT** In many developing countries, meeting the energy demand has become a major challenge. Such problem is more prominent in rural and remote areas of the country. The load requirements in these areas are less and the same can be addressed with renewable energy sources. The proposed work deals with a MPPT based standalone PV system using a priority controller. The system can be used to meet out the critical load demands in rural areas. Due to change in weather conditions, an unregulated output in PV array is observed. Hence, maximum power is tracked using a DC-DC converter, where the tracked data is with respect to temperature and irradiance levels. To acquire the maximum power point (MPP), an incremental conductance (IC) algorithm is employed and it is executed by controlling the duty cycle of DC-DC boost converter. Thus, the attainment of energy management in loads and battery storage is supported by priority load control algorithm. The proposed system assures better energy management and supplies energy for critical loads. The entire system has been simulated and validated using MATLAB/SIMULINK.

**INDEX TERMS** Photovoltaic, MPPT Algorithm, Converters, Priority Controller, Load Management, Standalone System

## 1. INTRODUCTION

The world without electricity is unimaginable. In a residential system, electrical energy is necessary for various applications namely lighting, heating, refrigeration, cooking, washing, entertainment etc., In industrial sector, electrical energy is utilized for operating various machineries [1][2]. The demand for electricity to a new user in a day-to-day basis is increasing rapidly and nearly, 2.1% increase in demand per year had been noticed. This drastic change is mainly due to global energy demand [3] and technological advancements in various sectors [4]. In conventional method, electrical energy is produced by the direct combustion of carbonaceous materials namely coal, oil and natural gas. These raw materials get depleted every day [5]. Thus, dependency of any system on fossil fuels has become unreliable. Apart from these issues, fossil fuels are the major cause for global warming and hazardous to the environment. Thus, there emerges a need for search of alternative sources towards addressing global warming problem as well as energy demand gap.

Solar, wind, geothermal, hydro and biofuels are the various alternative sources of energies [6]. Among these, the abundantly available energy source in across all parts of the world is solar energy [7]. Low capital investment and maintenance cost are the benefits of solar based system compared to other renewable energy-based systems [8]. Solar panels can be even set up in the roof top and hence, more land is not required for smaller applications [9]. Some of the recent advancements are floating solar farms or photovoltaics [10][11], Building Integrated Photovoltaics (BIPV) solar technology [12][13], Solar skins, Solar fabric [14], Space based solar etc. Grid-tied systems, Off-grid systems and Hybrid systems are the various options of solar power generation methods. In rural areas, particularly forest, mountain or islands that are far away from national or regional grid faces several power issues and lack of grid infrastructure. Also, the cost of such infrastructure development becomes costlier [15][16][17]. In such regions adopting off grid systems provides a cost effective, flexible solution when compared to grid connected system [18]. Uncertainties in weather, low solar irradiance

---

1 Corresponding author: [ashokudt@tce.edu](mailto:ashokudt@tce.edu)

, capital investment, energy storage are the major challenges associated with solar energy based off grid systems.

The proposed standalone system comprises of an array of photovoltaic cell ,charge controller,converter,battery bank, inverter,DC and AC loads[17].The charge controller regulates flow of power from panel to load, prevent battery from overcharging and discharging. At every instant, the maximum power point is tracked by MPPT and thus system efficiency gets increased. This further minimizethe complexity of the system[19],[21].Switching signals are produced for converter using the duty cycle produced by MPPT controller.

The solar PV works at optimal current and voltage, which is used for extracting maximum power by converter. The significance of power electronics support for a standalone PVsystem [20] is also vital for improving its performance. The need for battery in such system is to store excess energy produced by panels during daytimeandmanage the loads at nighttime [22].

Loads can be either DC or AC or both.In case of DC loads,the system is simple as dc output is directly supplied to load. But in case of AC load, the complexity increases as there is need of inverters for DC - AC conversion.The challenges in standalone system are load management, inefficient appliances and control coordination between solar, load and battery. Apart from these, instability issues are also noticed due to peak power at starting condition,reactive power and harmonic distortion [23]. Power generation in a solar based system gets affected by various environmental conditions and hence all loads cannot be supplied at all times.Therefore, a need for load management system becomes vital [24].

A standalone photo voltaic battery system with charge controller and inverter is proposed in [25], where loads have been categorized. In this, critical and non-critical loads are further used in [25].Priority rule-based load management technique is adopted. A high level of priority is assigned to the critical loads, while other loads cannot be operated in user's preferred time period.A priority load control algorithm for standalone PV system with battery bank is discussed in [26], where the optimal energy management is achieved between battery and available loads. These guarantees supply for critical loads and also provide better reliability.

An intelligent residential energy management systemhas been proposed [27] for smart buidlings, where analgorithm is developed for load scheduling with batteries to reduce electricity bills as well as for effective utilization of renewable energy.A hybrid system with ON and OFF grid operation is developed with inverter capable of operating in both on-grid and off-grid [28] where power management unit is designed to provide effective energy transfer to loads,battery and grid while increasing efficiency up to 10% rate.

## 2. RESEARCH GAP

Although various priority rule-based algorithms have been implemented for load management, the user faces several issues related to load switching. Critical loads have been assigned higher priority and minimum consideration is provided to supply non-critical loads.In current scenario, satisfying the energy demand for combination of various loads is yet to be addressed.

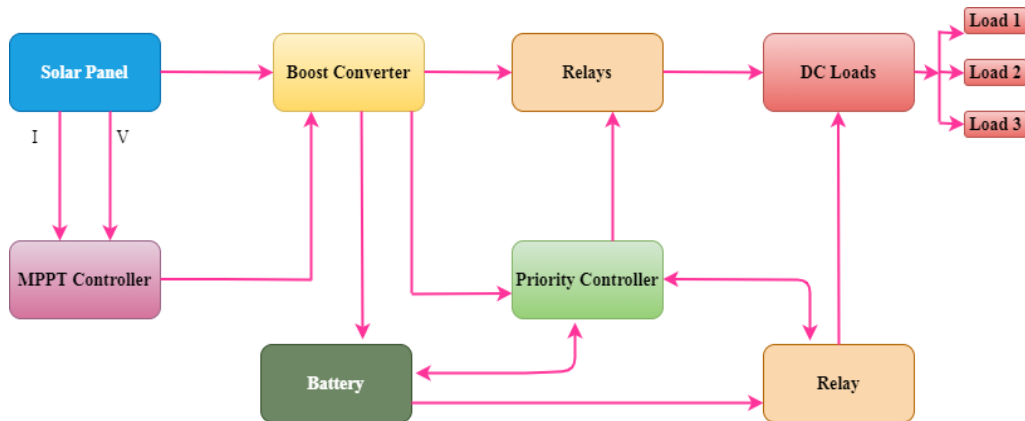
Based on the application requirement, loads can be selected. In this work, loads of a Primary Health Center has been considered for analysis because it is one of the major areas that require high level of attention in our society. Primary health centerplaysaimportant role in supporting people in rural area with medical assistance. The survey conducted among the various primary health centers in Madurai, Tamil Nadu, India helped to identify the problems faced by these centers namely patient diagnosis, vaccine storage etc due to power interruption. To address the research gap, a system has been proposed which comprises a standalone PV system with MPPT (Incremental conductance algorithm and boost converter),a priority controller for load management.

The user's demand is considered as the major input and control signals are generated to switch the loads between PV module and battery based on the available power.Various load combinations are consideredfor designing the priority controller and this will supply both critical and non-critical loads based on load priority and user requirement. The proposed system is implemented using MATLAB- SIMULINK.In this work, four loads have been considered,thus sixteen load combinations are simulated.Based on the available power from PV array and battery state of charge (SOC), loads are switched between PV and battery.

## 3. METHODOLOGY

In this system, PV is used as the primary source and battery for energy back-up as illustrated in Figure 1. A boost converter interfaces PV array with load for extracting maximum power from the panel. There are few vital factors that determine maximum power of a PV panel, such as solar irradiation, ambient temperature and cell temperature.Among the various

available MPPT techniques, Incremental conductance algorithm is used due to accuracy and faster response. Maximum power point is calculated by comparing incremental conductance ( $\Delta I / \Delta V$ ) with PV array conductance ( $I/V$ ) as shown in Figure 2.

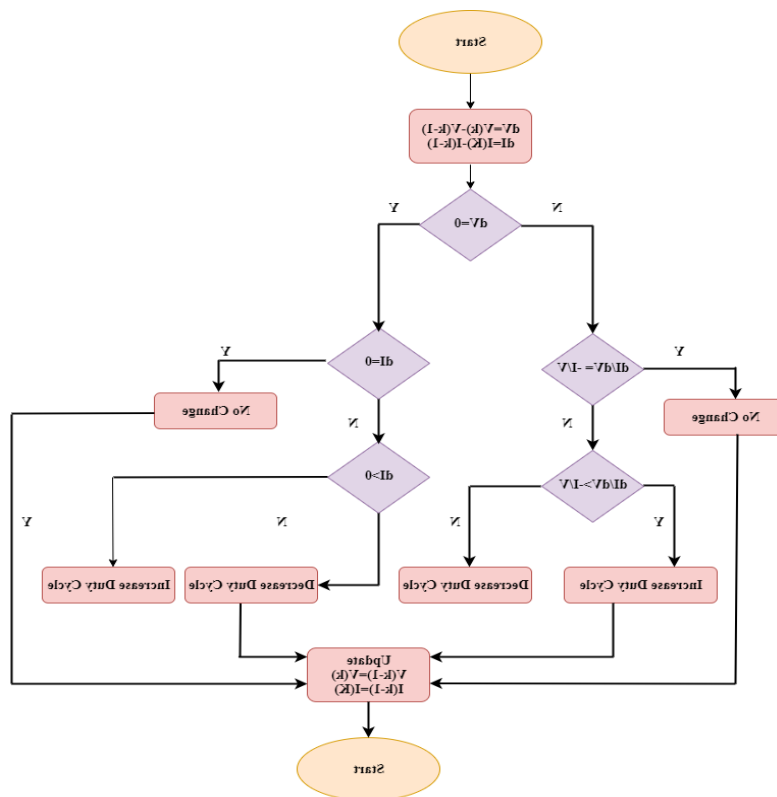


**FIGURE 1.**Block diagram of the proposed Standalone PV system

#### 4. INCREMENTAL CONDUCTANCE ALGORITHM FLOW CHART

A priority controller is designed in MATLAB Simulink, and it supports to manage the power requirement of both critical and noncritical loads depending upon the user’s demand. System specifications are highlighted in Table 1. Simulink

model of the PV standalone system is shown in Figure3. The standard value of PV panel irradiation and temperature is set to 1000W/m<sup>2</sup> and 25°C respectively. Incremental conductance algorithm fixes the maximum power with required duty cycle to generate PWM signal and the same is fed to IGBT switches of the boost converter.



**FIGURE 2.**MPPT Incremental Conductance algorithm

TABLE 1  
 SYSTEM SPECIFICATIONS

S.NO	COMPONENTS		RATING
1	PV ARRAY	Short circuit current(A)	7.84
		Open circuit voltage(V)	36.3
		Maximum power(W)	213
		Parallel strings	2
		Series-connected modules per string	2
2	CONVERTOR	Input voltage	60 V
		Output voltage	130 V
		Output current	5 A
		Switching frequency	7kHz
		Inductor	2.1 mH
		Capacitor	100 $\mu$ F
		3	LOADS
Refrigerator(100W)	144 $\Omega$		
Electric Kettle(150W)	96 $\Omega$		
Fan(40W)	360 $\Omega$		

### 5. RESULTS AND DISCUSSION

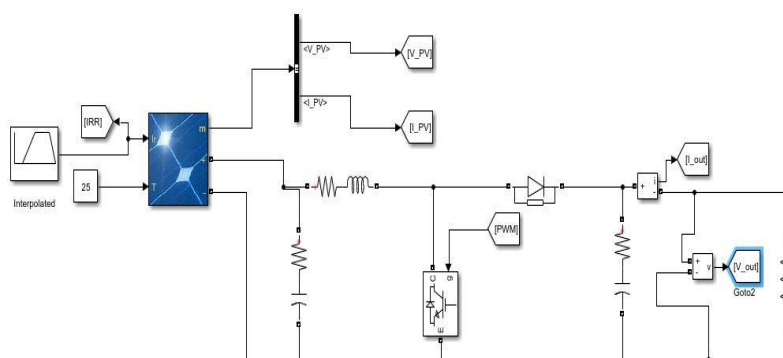
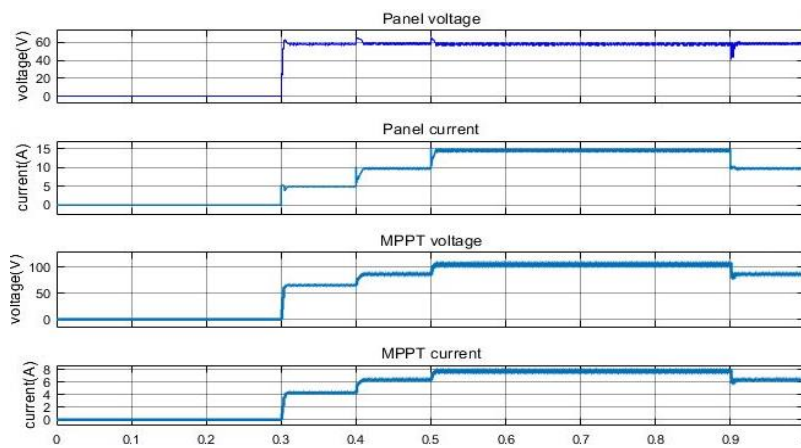


FIGURE 3.PV Standalone System Simulink Model

The loads in system are categorized as critical and non-critical, where 11,12,13,14 are critical loads as highlighted in Figure 5. Under all situations, supply need to be provided to all critical loads. The input power is obtained through MPPT voltage and current and is represented as P. The Battery State of Charge

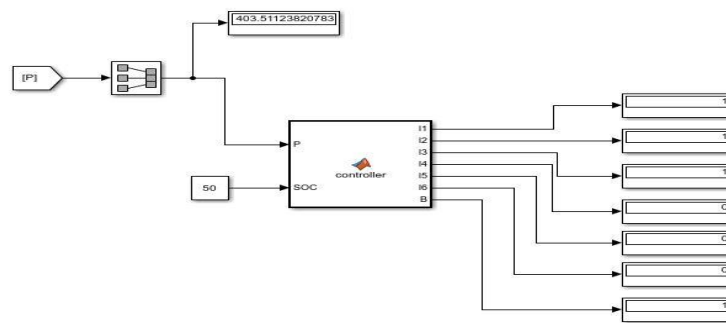
is denoted by SOC. The establishment of battery connection to panel depends on SOC level. When SOC is greater than 95% then the battery is disconnected from panel, else battery gets charged through the panel. This connection establishment is determined by the output side parameter B.



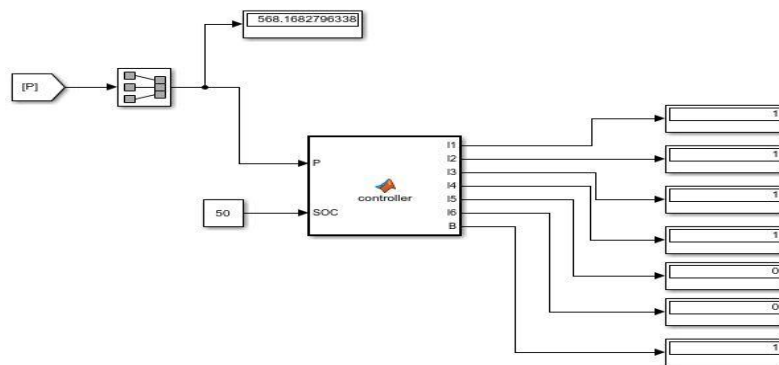
**FIGURE4(a)Panel voltage,(b)Panel current,(c)MPPT voltage,(d)MPPT current.**

From Figure 4(a) to (d), it is evident that the deployment of incremental conductance algorithm tracks the available maximum power and hence converter voltage is boosted.

To start with, initially the system is simulated with solar irradiance of  $700\text{W/m}^2$ . The power obtained for the given irradiance is  $403.5\text{W}$ . For this generated power, the loads I1,I2 and I3 are alone connected to the panel and is shown in Figure 5.



**FIGURE5. Priority controller with solar irradiance  $700\text{W/m}^2$**



**FIGURE6. Priority controller with solar irradiance  $1000\text{W/m}^2$**

Similarly, for solar irradiance of  $1000\text{W/m}^2$ ,  $568\text{ W}$  power is observed. For this power output, the loads I1,I2, I3 and I4 are alone connected to panel. Under such condition load I5,I6 are not connected to the panel and is represented in Figure 6. The inference made from simulation results emphasizes the inflexibility in load switching and hence user’s input for load management needs to be considered. This creates flexibility at user end, and it can be implemented by using modified priority controller. Such modified version of priority controller enables user to turn on or off any loads at any time according to their demand. Four loads are chosen for analysis have been listed in Table2, using these 16 load combinations

have been created and is specified in Table3.The modified priority controller can work under any of these load combinations. All the 16 load combinations are tested through simulation.

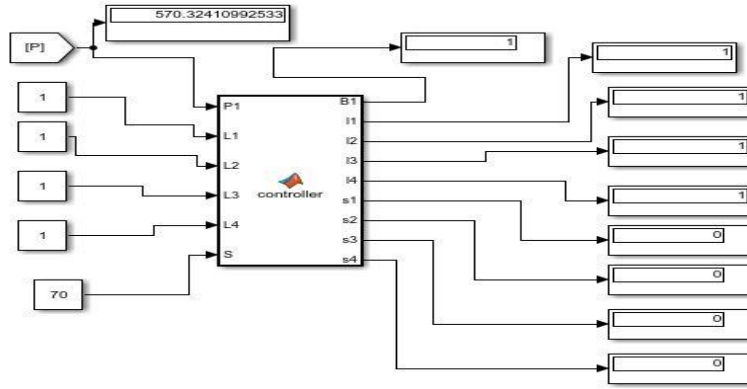
To analyze the system, four loads namely operation theatre light, refrigerator, electric kettle and fan have been considered and are shown in Table2. Using these four loads, 16 load combinations have been created to examine the modified priority controller performance. The modified controller version has been simulated using solar irradiance of 500 W/m<sup>2</sup>.The controller output in load management has been listed out in Table 3.

TABLEII  
 LOAD DETAILS

S.NO	LOAD	POWER(W)	PRIORITY
1.	Operation Theatre Light	250	1
2.	Refrigeration	100	2
3.	Electric kettle	150	3
4.	Fan	40	4

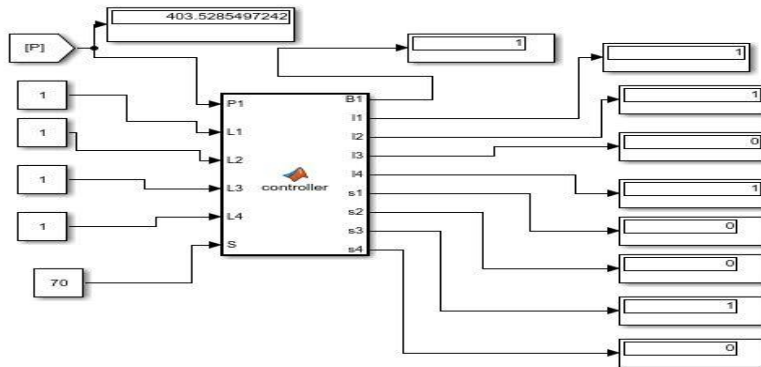
TABLEIII  
 MODIFIED PRIORITY CONTROLLER OUTPUT FOR IRRADIATION: 500W/m<sup>2</sup> WITH AVAILABLE POWER: 280

S.NO	L1	L2	L3	L4	Total Power	I1	I2	I3	I4	s1	s2	s3	s4
1.	0	0	0	0	0	0	0	0	0	0	0	0	0
2.	0	0	0	1	40	0	0	0	1	0	0	0	0
3.	0	0	1	0	150	0	0	1	0	0	0	0	0
4.	0	0	1	1	190	0	0	1	1	0	0	0	0
5.	0	1	0	0	100	0	1	0	0	0	0	0	0
6.	0	1	0	1	140	0	1	0	1	0	0	0	0
7.	0	1	1	0	250	0	1	1	0	0	0	0	0
8.	0	1	1	1	290	0	1	1	0	0	0	0	1
9.	1	0	0	0	250	1	0	0	0	0	0	0	0
10.	1	0	0	1	290	1	0	0	0	0	0	0	1
11.	1	0	1	0	400	1	0	0	0	0	0	1	0
12.	1	0	1	1	440	1	0	0	0	0	0	1	1
13.	1	1	0	0	350	1	0	0	0	0	1	0	0
14.	1	1	0	1	390	1	0	0	0	0	1	0	1
15.	1	1	1	0	500	1	0	0	0	0	1	1	0
16.	1	1	1	1	540	1	0	0	0	0	1	1	0



**FIGURE7. Output of modified priority controller with solar irradiance 1000W/m<sup>2</sup>**

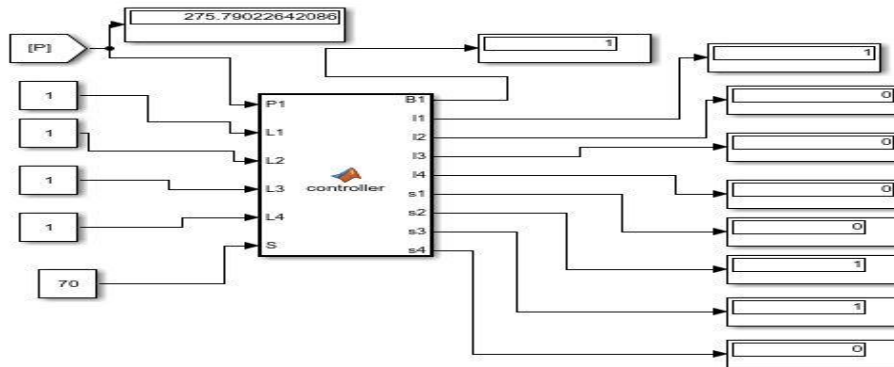
The modified priority controller block is shown in Figure7 has been simulated using solar irradiance of 1000W/m<sup>2</sup>, where 570.32 W input power is obtained from the MPPT voltage and current is represented as P and S represents the battery State of Charge (SOC).The user inputs are denoted as L1, L2, L3, L4 as noted in Table 3 which can be either 0 or 1 representing OFF or ON condition of the loads respectively. Users have the flexibility of turning ON or OFF any load at any time. Based on SOC level, the load can be connected either to panel or battery. To turn ON all the loads, 540 W is required but generated power is 570.32 W. Hence the entire loads can be supplied from panel and usage of battery can be neglected. This load management is shown in Figure 7.



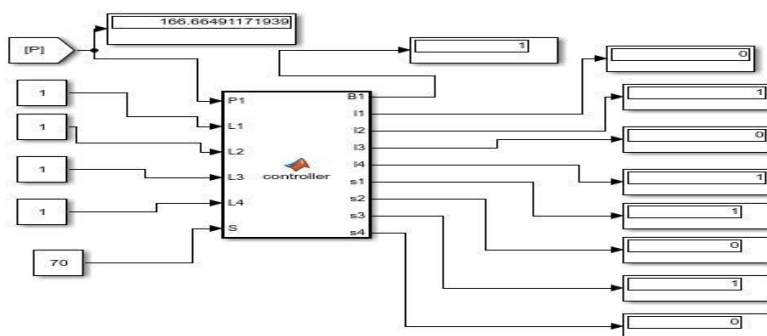
**FIGURE8. Output of modified priority controller with solar irradiance 700W/m<sup>2</sup>**

Similarly, for solar irradiance of 700W/m<sup>2</sup>, the power obtained is 403.52 W, which is insufficient to supply all loads at a time. The load priority L1>L2>L3>L4 is observed from Table 2. Based on this, loads L1, L2, L4 are connected to panel while load L3 is

connected to battery as represented in Figure 8. For solar irradiance of 500W/m<sup>2</sup>, the power obtained is 275.79 W. Figure 9 shows the load management where load L1 alone is connected to panel while load L2, L3 are connected to battery and L4 is disconnected from the system.

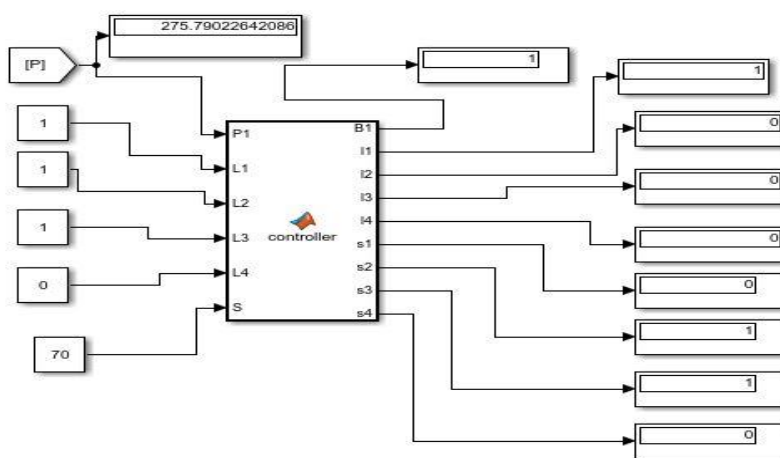


**FIGURE 9. Output of modified priority controller with solar irradiance 500W/m<sup>2</sup>**



**FIGURE10. Modified priority controller with irradiance 300W/m<sup>2</sup>**

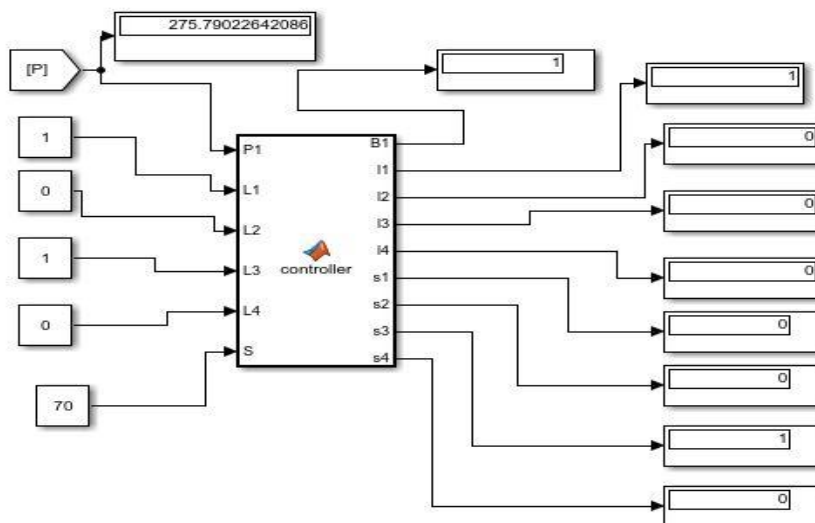
For the irradiance value of 300W/m<sup>2</sup>, the power obtained is around 166.6W. This power cannot supply all the four loads, thus the loads L2, L4 are connected to panel and the loads L1, L3 are connected to battery as represented in Figure 10.



**FIGURE11. Modified priority controller with solar irradiance 500W/m<sup>2</sup>**

For a solar irradiance of 500W/m<sup>2</sup>, generated power is 275.79 W. By considering the user requirement, 3 loads have been managed using modified priority

controller. Simulated results shown in Figure 11 have been validated with data in Table 3.





**FIGURE12. Modified priority controller with irradiance 500W/m<sup>2</sup>**

When the user demand is only 2 loads with solar irradiance of 500W/m<sup>2</sup> and 275.79 Wpowergenerated, the modified priority controller connects L1 to panel and L3 to battery. The obtained simulation results match with expected results shown in Table 3.

**6. MODIFIED PRIORITY CONTROLLER**

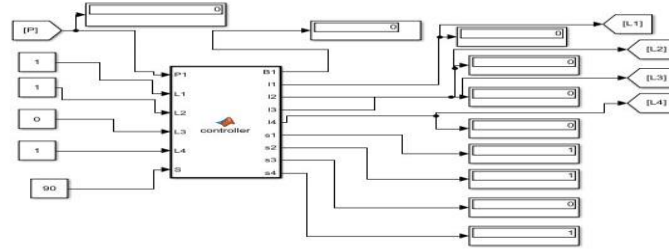
During the daytime, the loads can be connected to panel or battery based on power generation and priority. During nighttime when the generation is Nil, the only source available is battery. The 16 different combinations of loads are taken into account in the night time scenario and are switched on or off according to the battery State of charge (SOC).

TABLEIV  
 EXPECTED RESULTS COMBINATIONS OF LOAD AND SOC

Irradiation: 0W/m<sup>2</sup> Power available: 0

S.NO	L1	L2	L3	L4	Battery Range SOC (%)	s1	s2	s3	s4
1.	0	0	0	0	0-100	0	0	0	0
2.	0	0	0	1	≥20	0	0	0	1
3.	0	0	1	0	≥20	0	0	1	0
4.	0	0	1	1	≥40	0	0	1	1
					20-39	0	0	1	0
5.	0	1	0	0	≥20	0	1	0	0
6.	0	1	0	1	≥40	0	1	0	1
					20-39	0	1	0	0
7.	0	1	1	0	≥40	0	1	1	0
					20-39	0	1	0	0
8.	0	1	1	1	≥60	0	1	1	1
					40-59	0	1	1	0
					20-39	0	1	0	0
9.	1	0	0	0	≥20	1	0	0	0
10.	1	0	0	1	≥40	1	0	0	1
					20-39	1	0	0	0
11.	1	0	1	0	≥40	1	0	1	0
					20-39	1	0	0	0
12.	1	0	1	1	≥60	1	0	1	1
					40-59	1	0	1	0
					20-39	1	0	0	0
13.	1	1	0	0	≥40	1	1	0	0
					20-39	1	0	0	0
14.	1	1	0	1	≥60	1	1	0	1
					40-59	1	1	0	0
					20-39	1	0	0	0
15.	1	1	1	0	≥60	1	1	1	0
					40-59	1	1	0	0
					20-39	1	0	0	0
16.	1	1	1	1	≥80	1	1	1	1
					60-79	1	1	1	0
					40-59	1	1	0	0
					20-39	1	0	0	0

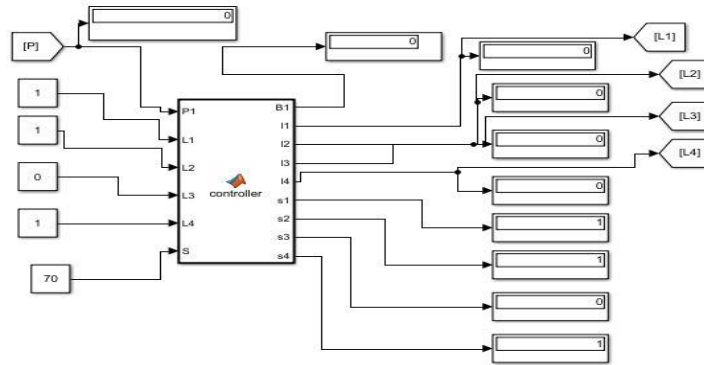
All possible combinations of load and SOC are simulated, and the outputs are tabulated in the Table4. User input of 3 loads is considered and battery SOC is varied, simulated and the outputs obtained are shown in Fig.11 –Fig.14. The outputs obtained are compared with the expected results in Table4, and both are same. Here the user chooses 3 loads such as L1, L2 and L4 to be in ON state.



**FIGURE13. Modified priority controller with irradiance 0W/m<sup>2</sup> and SOC 90%**

When the user demand is only 3 loads, irradiance is 0W/m<sup>2</sup> and the SOC is 90%, all three loads are connected to the battery as shown in Figure 11,

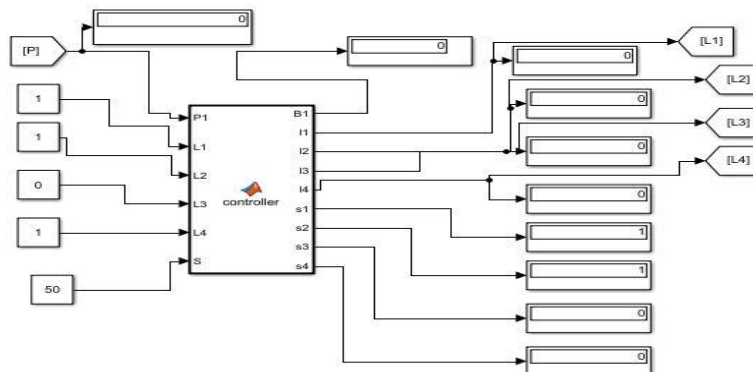
because the code is written such that if SOC is greater than 60%, the battery could supply 3 loads. The obtained result as shown in Figure 13 is the same as the result expected in Table3.



**FIGURE14. Modified priority controller with irradiance 0W/m<sup>2</sup> and SOC 70%**

When the user demand is only 3 loads, irradiance is 0W/m<sup>2</sup> and the SOC is 70%, all three loads are

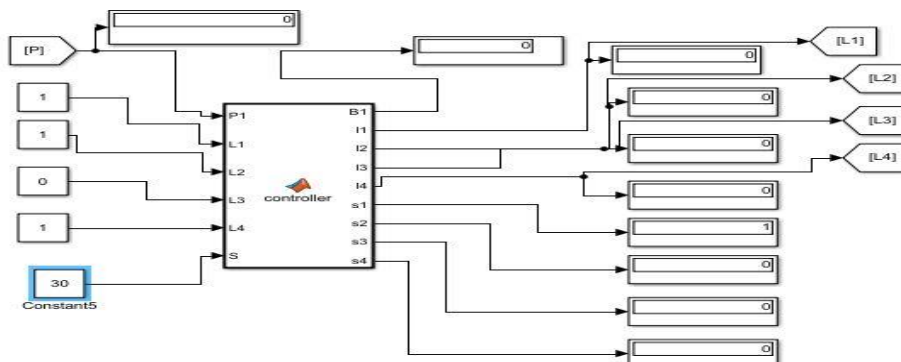
connected to the battery as shown in Figure 12. The obtained result as shown in Figure 14 is the same as the result expected in Table3.



**FIGURE15. Modified priority controller with irradiance 0W/m<sup>2</sup> and SOC 50%**

When the user demand is only 3 loads, irradiance is  $0W/m^2$  and the SOC is 50%, according to the code, only prioritized 2 loads can be connected to the

battery and the 3<sup>rd</sup> load is not connected as shown in Figure 13. The obtained result as shown in Figure 15 is the same as the result expected in Table 3.



**FIGURE16. Modified priority controller with irradiance  $0W/m^2$  and SOC 30%**

When the user demand is only 3 loads, irradiance is  $0W/m^2$  and the SOC is 30%, according to the code, only top prioritized load can be connected to the battery and the other loads are not connected as shown in Figure 13. The obtained result as shown in Figure 16 is the same as the result expected in Table 3. Thus all the 16 different load combinations are executed and verified with the values in the Table 3. The results are compared with the Table values and the outcome is obtained successfully.

## 7. CONCLUSION

The proposed system can provide solution to power related problems encountered by Primary Health Care Centers. The PV standalone system with priority and modified priority controller results have been validated against four standards load that are used in Primary Health Centers. In conventional method, the user requirements in switching the loads were not considered and hence priority loads alone were managed. Inference made from simulation results highlighted the inflexibility in load switching. To create flexibility at user end, a modified priority controller has been proposed, which incorporates user requirements during load management. The implementation of novel priority controller algorithm supports in managing both critical and noncritical load at any time. The developed algorithm can be implemented to any standalone system.

## 8. REFERENCE

1. Silva, A.R.; Estanqueiro, Energies, 15, 2560. <https://doi.org/10.3390/en15072560> (2022).
2. Ibrahim Dincer, Yusuf Bicer, Chapter 6 - Integrated Energy Systems for Multigeneration, Elsevier, Pages 287-402, (2020).
3. Sean Williams, Michael Short-Electricity demand forecasting for decentralised energy management Energy and Built Environment Volume 1, Issue 2, April, Pages 178-186 (2020).
4. Muhammad Najmi, Rinaldy Dalimi IEEE- International Conference on Electrical Engineering and Computer Science (ICECOS) (2019).
5. Mahmood H. Shubbak-Advances in solar photovoltaics: Technology review and patent trends, Renewable and Sustainable Energy Reviews Volume 115, November, 109383 (2019).
6. Miyan, Mohammad & Shukla, M. Review on Non-Conventional Energy Resources in India. SAMRIDDI : A Journal of Physical Sciences, Engineering and Technology. 10. 10.18090/samriddhi.v10i02.2. (2018).
7. Kihlström, V.; Elbe, J. Constructing Markets for Solar Energy—A Review of Literature about Market Barriers and Government Responses. Sustainability, 13, 3273. <https://doi.org/10.3390/su13063273>, (2021).
8. Singh, Gurjit & Kapila, Neha & Singh, Pawanpreet & Bains, Rohit. Solar Energy: Trends and Enabling Technologies for Green Electricity. 4. 112-116. (2017).
9. Osama Bany Mousa, Sami Kara, Robert A. Taylor-Comparative energy and greenhouse gas assessment of industrial rooftop-integrated PV and solar thermal collectors, Applied Energy Volume 241, 1 May, Pages 113-123 (2019).

10. Challa, Santhi&Bethanabhotla, Sameer &Kasina, Satwik&Sudha, Radhika. . Recent Developments and Future Advancements in Solar Panels Technology. *Journal of Physics: Conference Series*. 1495. 012018. 10.1088/1742-6596/1495/1/012018. (2020).
11. Al-Widyan, M.; Khasawneh, M.; Abu-Dalo, M. Potential of Floating Photovoltaic Technology and Their Effects on Energy Output, Water Quality and Supply in Jordan. *Energies*, 14, 8417. <https://doi.org/10.3390/en14248417>. (2021).
12. JoanaAbreu,NathalieWingartz,NatashaHardy-New trends in solar: A comparative study assessing the attitudes towards the adoption of rooftop PV, *Energy Policy*Volume 128, May, Pages 347-363 (2019)
13. AkashKumarShukla,K.Sudhakar,PrashantBaredar,RizalmanMamat-Solar PV and BIPV system: Barrier, challenges and policy recommendation in India *Renewable and Sustainable Energy Reviews*Volume 82, Part 3, February, Pages 3314-3322 (2018).
14. J. Liu, Y. Li, S. Yong, S. Arumugam, S.P. Beeby, "Flexible Printed Monolithic-Structured Solid-State Dye Sensitized Solar Cells on Woven Glass Fibre Textile for Wearable Energy Harvesting Applications", *Scientific Reports*, vol. 9, no. 1362, pp. 1-10, (2019).
15. Solar subsidies: Government subsidies and other incentives for installing rooftop solar system in India,[https://economictimes.indiatimes.com/small-biz\\_/productline\\_/power-generation/solar-subsidies-government-subsidies-and-other-incentives-for-installing-rooftop-solar-system-in-india/articleshow\\_/69338706.cms?from=mdr](https://economictimes.indiatimes.com/small-biz/_productline_/power-generation/solar-subsidies-government-subsidies-and-other-incentives-for-installing-rooftop-solar-system-in-india/articleshow_/69338706.cms?from=mdr), last accessed 20/07/2022.
16. Solar rooftop subsidy for 10,000 customers in TN,<https://www.thehindubusinessline.com/news/national/solar-rooftop-subsidy-for-10000-customers-in-tn/article64206644.ece>, last accessed 20/07/2022.
17. Leblebicioğlu, Emre. User-Focused Designing and Pricing of an Off-Grid Photovoltaic Solar Energy System. (2019).
18. D. H. Arthanto, A. ImanMalakani, B. G. DwiWicaksono and A. Purwadi, "Off-Grid PV System Modelling for Communal Load at Jifak Village-Asmat Regency, Papua Province Based on MATLAB/Simulink," 2nd International Conference on High Voltage Engineering and Power Systems (ICHVEPS), 2019, pp. 322-327, doi: 10.1109/ICHVEPS47643.2019.9011073. (2019).
19. ZiebaFalama, Ruben. Maximum Power Point Tracking of Photovoltaic Energy Systems Based on Multidirectional Search Optimization Algorithm. *International Journal of Renewable Energy Research*. 11. 546-555. (2021).
20. Carlos Olalla,DraganMaksimovic,ChrisDeline,L. Martinez-Salamero- Impact of distributed power electronics on the lifetime and reliability of PV systems, Article in *Progress in Photovoltaics Research and Applications* , April (2017).
21. Dolara, A.; Grimaccia, F.; Mussetta, M.; Ogliari, E.; Leva, S. An Evolutionary-Based MPPT Algorithm for Photovoltaic Systems under Dynamic Partial Shading. *Appl. Sci.*, 8, 558. <https://doi.org/10.3390/app8040558>. (2018).
22. Jhud MikhailAberilla,AlejandroGallego-Schmid,LaurenceStamford,AdisaAzapagic- Design and environmental sustainability assessment of small-scale off-grid energy systems for remote rural communities *Applied Energy*Volume 258, 15 January, 114004 (2020).
23. Ziar, Hesam&Manganiello, Patrizio& Isabella, Olindo&Zeman, Miro. Photovoltaics: Intelligent PV-based devices for energy and information applications. *Energy & Environmental Science*. 14. 10.1039/d0ee02491k. (2020).
24. Systems through load management *Applied Energy*Volume 231, 1 December, Pages 926-93 (2018).
25. T.R.Ayodele,A.S.O.Ogunjuyigbe,K.O.Akpeji,O.O.Akinola - Prioritized rule based load management technique for residential building powered by PV/battery system, *Engineering Science and Technology, an International Journal*Volume 20, Issue 3, June, Pages 859-87 (2017).
26. Abbas, Alaa&Obed, Adel &Abid, Ahmed. Design of a Smart Energy Management System for Photovoltaic Stand-Alone Building Design of a Smart Energy Management System for Photovoltaic Stand-Alone Building. *IOPConference Series: Materials Science and Engineering*. 881. 10.1088/1757-899X/881/1/012158. (2020).
27. S. L. Arun and M. P. Selvan , Member, IEEE - Intelligent Residential Energy Management System for Dynamic Demand Response in Smart Buildings, *IEEE Systems Journal*, Vol. 12, No. 2, June (2018).
28. KivancBasaran ,NumanSabit Cetin, SelimBorekci - Energy management for on-grid and off-grid wind/PV and battery hybrid systems, *IET Renew. Power Gener.*, , Vol. 11 Iss. 5, pp. 642-649 (2017).