

Prospect for the use of the solar updraft tower project for the generation of electrical energy in the republic of Uzbekistan

Almuhan Nuraliyev ^{1*}, Yalkin Adilov ², Azamat Esenbekov ³

¹ Tashkent State Technical University named after Islam Karimov, 100095, Uzbekistan, Tashkent, University St. 2A

² Tashkent University of Irrigation and Agricultural Mechanization Engineers, 39 Kari Niyazi str., Tashkent, Uzbekistan

³ Karakalpak State University named by Berdakh, 1 Ch.Abdirov str. Nukus, Uzbekistan

Abstract. Fulfilling the decision of the Paris Agreement on Climate Change (COP-21 of the UNFCCC) dated December 12, 2015, the government of the Republic of Uzbekistan has developed and adopted an energy development plan of the Republic for 2020-2030. The plan provides for the construction of 3 GW of wind and 5 GW of solar power plants annually. RES will generate electrical energy in parallel with the generation of energy by thermal stations and transfer it to the general energy system. The main disadvantage of the joint operation of RES and thermal power plants is the need to have standby generating capacity due to the fact that the sources of solar and wind energy are fickle by nature. System costs rise with the increasing share of renewable energy sources. The Solar Updraft Tower project is a renewable energy option that does not have the main disadvantage of other types of renewable energy sources - the variability of electricity production and therefore is more acceptable for operating conditions in a single energy system. The article discusses and evaluates the Solar Updraft Tower (SUT) project for the generation of electrical energy, taking into account the conditions of Uzbekistan.

1 Introduction

Today's generation of electricity from coal, oil and natural gas is environmentally damaging, unsustainable in terms of pricing, and many developing countries cannot afford these energy sources [1-4]. A reasonable technology for the widespread use of renewable energy sources should be:

- a) simple and reliable;
- b) affordable for technologically less developed countries;
- c) should not require additional water resources for cooling;
- d) do not produce waste and use environmentally friendly production from renewable or recyclable materials.

The Solar Updraft Tower (SUT) project meets these conditions and makes it possible to take a decisive step towards a global solar energy economy. Economic evaluations based on experience and knowledge accumulated to date [2-6] have shown that large-scale SUTs (≥ 100 mW) are capable of generating energy at prices close to those of conventional power plants. sharply increasing demand, will soon balance the difference in value today, and tomorrow will completely change it. Another argument in favor of the NSC is the global climate change that began in 2018-2020 and requires an immediate solution to the problem of replacing the energy production system from

hydrocarbons with energy obtained from alternative sources, regardless of the price of oil. Our opinion is that in the very near future the SUT project will be able to take part in solving one of today's main tasks: the production of sustainable, inexhaustible and affordable energy. According to WEA today: in Australia, under the project of S.N.B, a station for the production of electricity with a capacity of 50 MW was built. Under the plans of the Enviromission Commission, two versions of 200 MW each are currently under construction, using 32 6.25 MW turbines with a collector area of 10 square kilometers under a tower 730 meters high in the Arizona desert. The thermal mass - possibly salt ponds - under the collector zone means power generation will continue into the night. A 50 kW prototype plant of this design operated in Spain in 1982-89. China is building a 27.5 MW solar rising tower in Jinshawan [3-7]. Estimates of the cost of electricity generated range from €0.05 per kilowatt-hour (kWh) to €0.25 (US\$0.07 to \$0.34 per kWh), depending on land value and financing scenario. By comparison, a conventional gas-fired power plant can produce electricity for as little as 0.05 EUR/kWh. Start projects also enable the development of other applications such as agriculture or horticulture, to extract or distill water, or to improve air pollution in cities.

* Corresponding author: raxmatillo82@mail.ru

2 Research Method

The technological principle of generating electrical energy using SUT is quite simple: under a large glass roof, the sun heats the air [4-8]. Under the influence of the greenhouse effect, the air under the glass roof (collector) heats up more than the air outside and an excess pressure appears, which in turn creates an air flow that is sucked in by a central vertical cylindrical pipe - a chimney. The air flow drives the turbines - generators installed in the chimney, which generate electricity.

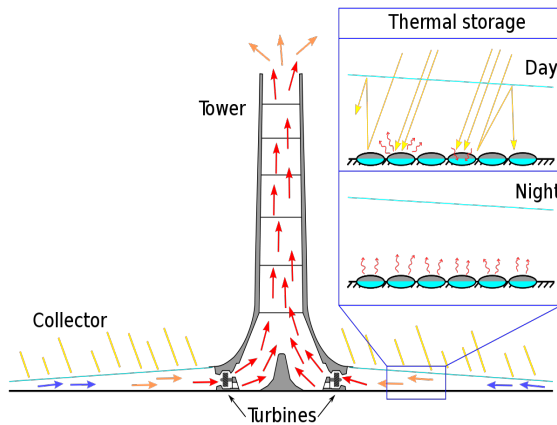

Fig 1. Basic parameters of the SUT

Because the soil below the collector acts as a natural heat storage system, SUTs can run 24 hours on pure solar power with some power reduction at night. Simple water pipes mounted on the ground increase the total heat capacity of the SNB by heating the water in these pipes, during the day and at night this heat warms the air and maintains pressure under the collector.

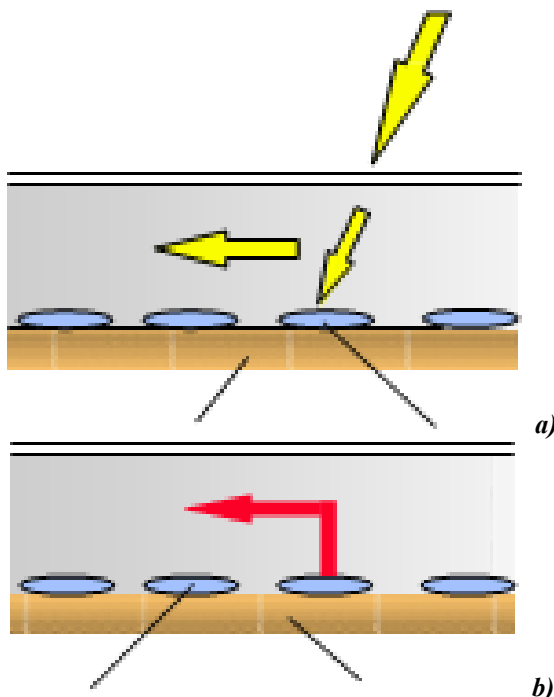

Fig 2. Accumulation of thermal energy in the SUT system

During the day, under the action of solar radiation, heat is accumulated in the water (Fig. 2a), at night, on the contrary, heat is transferred from the water into the air (Fig. 2b). The volume of water in the tubes is chosen to fit a water layer with a depth of 5 to 20 cm depending on the required power output characteristics.

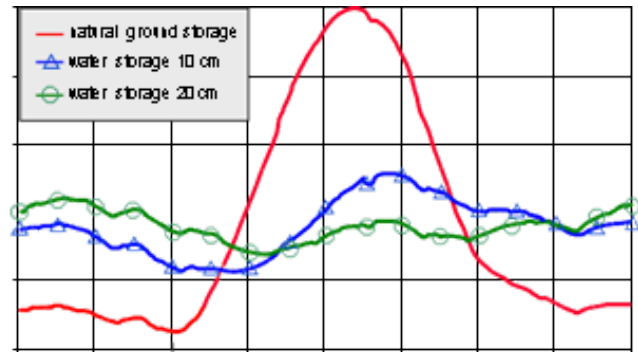

Fig. 3 Change in the power generated by SUT within 24 hours

The electrical output of a solar ascending tower is proportional to the air volume in the tower and the collector area (Figure 1). In other words, one can increase the collector area and decrease the height of the tower, and the same result can be obtained by increasing the height of the tower and decreasing the collector area.

3 Production of electrical energy

The energy contained in the updraft is converted into mechanical energy using stepped turbines which the base of the tower and into electrical energy using conventional wind turbines [5, 9-12].

Using wind turbines, we obtain mechanical power in the form of rotational energy from the air flow in the tower. The turbines in the solar ascending tower do not operate in step speed control, as in a conventional wind power converter, but as a smoothly controlled hydro-generator in which static pressure is converted into rotational energy [6, 13-16].

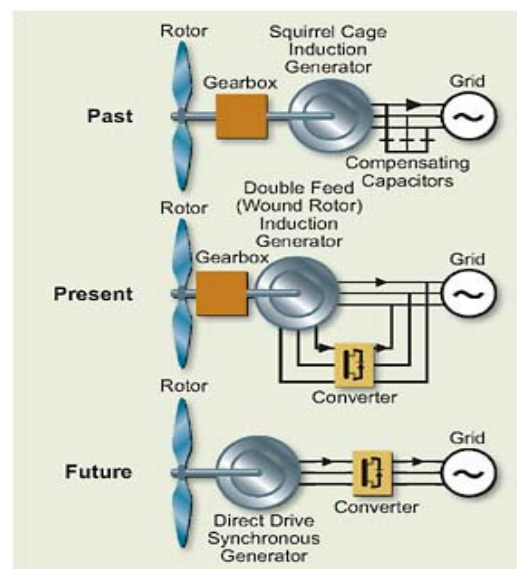

Fig. 4. Types of wind turbines used in SUT

The specific power output (power per area covered by the rotor) in a solar pressure tower is about an order of magnitude higher than that of a conventional Wind Turbine Generator (WTG). The air flow rate before and after the turbine is approximately the same. In order to maximize energy yield, the goal of the turbine control system is to maximize electrical energy yield under all operating conditions [7, 17-19]. To this end, the pitch of the blade is adjusted during operation to adjust the power output according to changing airspeed and airflow.

4 WTG subsystem model

The aerodynamics of the WTG generates the power as a function of wind speed given by:

$$P_{WTG} = 12\rho A r C_p V w^3 \quad (1)$$

where, ρ represents air density having unit kg/m^3 , generally constant for particular location of installation, $A r$ and C_p are the swept area (m^2) of blades of a particular turbine and the coefficient of power. $V w$ represents wind speed. The transfer function (i.e. in first order form) may also be given as a lag compensator as:

$$G_{WTG}(s) = K_{WTG} / (1 + s T_{WTG}) = \Delta P_{WTG} / \Delta P_w \quad (2)$$

where, K_{WTG} is WTG 's gain constant and T_{WTG} is WTG's time constant.

The angle of rotation of the turbine blades is controlled depending on the operating mode of the frequency inverter (Fig. 4 models "present&future").

5 Results and Discussion

Using SUT in agriculture. An important side effect of placing a large transparent membrane above the ground is to capture the evaporated groundwater and return it back to the topsoil [8, 20-22]. This localized increase in ground moisture can make the soil below the collector suitable for agricultural use by effectively creating a partial greenhouse. In some cases, the land below the collector would not be viable for agriculture without the presence of a membrane. This means that some badlands can be put to productive use, making this energy production strategy more cost effective while building agricultural capital.

The clearance height below the collector can easily accommodate agricultural equipment, and the collector supports can be far enough apart to allow the land to be farmed. The farming system, combined with the updraft tower, can be applied both as a sustainable economic strategy and for the recovery of agriculture in developing countries.

Using SUT with PV panels. Use with other solar technologies, such as plants that use solar radiation to produce EE using photovoltaic (PV). The main disadvantage of PV panels is their strong heating during the generation of EE [9, 23-24]. The use of a solar ascending tower in combination with photovoltaic arrays can increase the efficiency of both systems. The constant

wind flow can cool the PV collectors with air while increasing the power output per area of land used, which makes the solar rising tower more efficient.

Combining these systems creates: 1. the loss of some direct solar radiation as a result of its deflection by the membrane. 2. Additional cooling of PV elements due to constant blowing.

Optimization of SUT usage. The quality and quantity of electrical energy received from the solar ascending tower, as well as the economic efficiency of the project, depend on the following factors: 1. the intensity of global solar radiation. 2. SUT parameters (collector area and tower height). 3. Cost of land to be used for the SUT project. 4. The cost of materials and labor that will be used in the implementation of the project [10, 15-17].

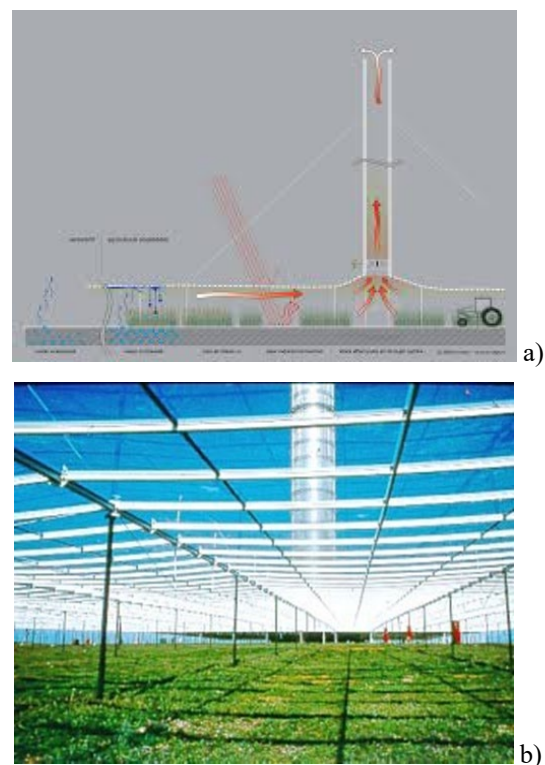

Fig. 5. General scheme of the electrical energy and agricultural production based on the SUT.

- a) scheme of production of electrical energy;
- b) general view of agricultural SUT

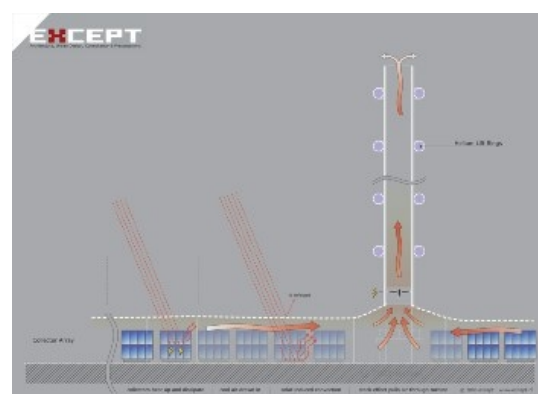

Fig. 6. Scheme of SUT with additional PV collector

Table 1. Typical dimensions of SNB and power generation

SUT power		50 mW	100 mW	200 mW
Height of tower	m	750	1000	1000
Towers diameter	m	90	110	120
Collectors diameter	m	3750	4300	7000
The amount of electricity with solar radiation 2300kWh/m2+	GW in hour	153	320	680
The amount of electricity with solar radiation 1800kWh/m2+	GW in hour	120	250	532
Towers Cost	mIn€	72	192	192
Labor cost		18€	18€	5€
Collectors cost	mIn€	142	430	390
Turbine + generator cost	mIn€	56	146	146
The cost of electricity with solar radiation 2300 (kWh \ m2 year) A	€\kV hour	0.19	0.15	0.12
The cost of electricity with solar radiation 1800 (kWh \ m2 year) A	€\kV hour	0.25	0.2	0.16

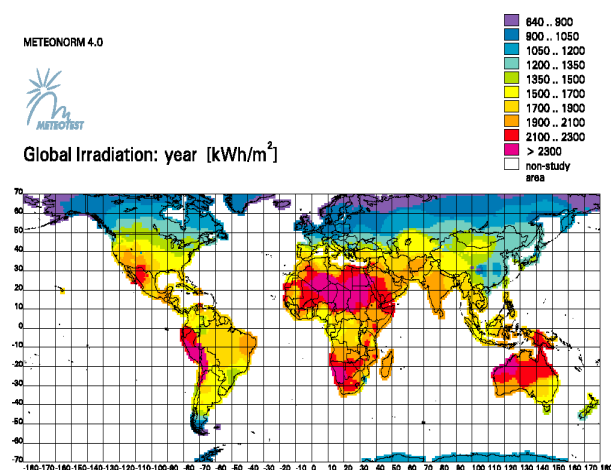

Fig. 7. Map of global solar radiation

Many areas and countries in the Earth's solar belt, that is, a zone around 35° north and south of the equator, are suitable for solar rising towers. As a general rule, annual global horizontal radiation must equal or exceed 1800 kWh/m². There really is no optimal physical size for SUT power plants [11, 25-27]. Optimal dimensions can only be calculated by including the unit costs of the components (collector, column, turbines) for individual sites. Thus, plants with different optimal key dimensions will be built for different sites, but always at the optimal price: if the collector area is cheap and concrete is expensive, then the collector will be large, and the tower is relatively small, and if the land under the collector is expensive, then its area will be smaller but the tower is higher.

For a quick overview, typical dimensions for selected capacities of a solar ascending tower are shown in Table 1. These figures are based on typical material and construction costs [12-16].

Conclusion

The possibility of using the SUT project in the conditions of Uzbekistan. According to the map of solar radiation Fig. 7, Uzbekistan is located in a climatic zone where the level of solar radiation is (1900-2100) kWh/m2 year, and the SUT project is recommended for use. In economic calculations, indicators of the cost of land and labor are of great importance, which will be used for the economic justification of the use of the SUT complex. square meter (1-1.5) \$. As for the cost of using labor, in the Republic there is a large surplus of it and, accordingly, prices are much less than 5 € indicated in Table 1. If we add here the relative cheapness of building materials that will be used to build the SUT, then the cost of the project can be reduced by (25- 30)% compared with the data in Table 1. Taking into account the above, we propose to implement the SUT project with a unit capacity of 100 MW in Yangiaryk district, Khorezm region, Uzbekistan. 110.5 thousand people permanently live in the region, concentrated in the south of the territory. Electric energy is consumed in the amount of 8 million. kWh per month or 96 million kWh per year. In the district, as a result of the survey, there is an area of 200 hectares unused for agriculture, covered with sand (photo Fig. 8).



Fig. 8. Photo of the site for the placement of the SUT complex in the Yangiaryk district, Khorezm region

Currently, active work is underway on the project, taking into account the standards developed by the Ministry of Innovation of the Republic of Uzbekistan.

References

1. Saad Mekhilef, and others. Journal of Thermal Analysis and Calorimetry, **141**, p.649-668, (2020).
2. K.G.Abidov, A.K.Nuraliev, and others. Journal of Advanced Research in Dynamical and Control Systems, **12(7)**, pp. 2167-2171, (2020).
3. A.K.Nuraliev, and others. E3S Web of Conferences, **216**, **01108**, (2020), <https://doi.org/10.1051/e3sconf/202021601108>
4. M.Ibadullaev, A.Nuraliev, A.Esenbekov. IOP Conference Series: Materials Science and Engineering, **862(6)**, **062031**, (2020), [DOI 10.1088/1757-899X/862/6/062031](https://doi.org/10.1088/1757-899X/862/6/062031)
5. R.Karimov. AIP Conference Proceedings, **2552**, **030014**, (2022). <https://doi.org/10.1063/5.0111533>
6. R.Karimov. AIP Conference Proceedings, **2552**, **050012**, (2022). <https://doi.org/10.1063/5.0111524>
7. S.Dzhuraev, R.Karimov, and others. ElConRus, (2022), pp. 1166-1169, [doi: 10.1109/ElConRus54750.2022.9755782](https://doi.org/10.1109/ElConRus54750.2022.9755782)
8. R.Karimov, A. Kuchkarov, and others. Journal of Physics: Conference Series **2094**, **052050**, (2021). [doi:10.1088/1742-6596/2094/5/052050](https://doi.org/10.1088/1742-6596/2094/5/052050)
9. R.Karimov, N.Kurbanova, and others. Journal of Physics: Conference Series **2094(5)**, **052042**, (2021). [doi:10.1088/1742-6596/2094/5/052042](https://doi.org/10.1088/1742-6596/2094/5/052042)
10. K.G.Abidov, O.O.Zaripov, and others. AIP Conference Proceedings, **2552**, **030023**, (2022), <https://doi.org/10.1063/5.0112385>
11. K.G.Abidov, O.O.Zaripov, and others. AIP Conference Proceedings, **2552**, **030022**, (2022), <https://doi.org/10.1063/5.0112384>
12. K.G.Abidov, O.O.Zaripov, and others. E3S Web of Conferences, **289**, **07003**, (2021), <https://doi.org/10.1051/e3sconf/202128907003>
13. K.G.Abidov, and others. E3S Web of Conferences, **289**, **07004**, (2021), <https://doi.org/10.1051/e3sconf/202128907004>
14. K.Abidov, N.Khamudkhanova. E3S Web of Conferences, **216**, **01111**, (2020), <https://doi.org/10.1051/e3sconf/202021601111>
15. K.G.Abidov, O.O.Zaripov, and others. E3S Web of Conferences, **216**, **01110**, (2020), <https://doi.org/10.1051/e3sconf/202021601111>
16. K.G.Abidov, O.O.Zaripov. E3S Web of Conferences, **139**, **01088**, (2019), <https://doi.org/10.1051/e3sconf/201913901088>
17. E.Kh.Abduraimov, D.Kh.Khalmanov. Journal of Physics: Conference Series, **2373(7)**, **072010**, (2022), [DOI 10.1088/1742-6596/2373/7/072010](https://doi.org/10.1088/1742-6596/2373/7/072010)
18. E.Kh.Abduraimov. Journal of Physics: Conference Series, **072009**, **2373**, (2022), [DOI 10.1088/1742-6596/2373/7/072009](https://doi.org/10.1088/1742-6596/2373/7/072009)
19. E.Abduraimov, M.Peysenov, N.Tairova. AIP Conference Proceedings, **2552**, **040012**, (2022), <https://doi.org/10.1063/5.0116235>
20. E.Kh.Abduraimov, D.Kh.Khalmanov. Journal of Physics: Conference Series, **2094(2)**, **022072**, (2021), [DOI 10.1088/1742-6596/2094/2/022072](https://doi.org/10.1088/1742-6596/2094/2/022072)
21. E.Kh.Abduraimov, D.Kh.Khalmanov, and others. E3S Web of Conferences, **289**, **07026**, (2021), <https://doi.org/10.1051/e3sconf/202128907026>
22. E.Kh.Abduraimov, D.Kh.Khalmanov. E3S Web of Conferences, **216**, **01106**, (2020), <https://doi.org/10.1051/e3sconf/202021601106>
23. E.Kh.Abduraimov. E3S Web of Conferences, **216**, **01105**, (2020), <https://doi.org/10.1051/e3sconf/202021601105>
24. E.Kh.Abduraimov, D.Kh.Khalmanov. Journal of Physics: Conference Series, **1515(2)**, **022055**, (2020), [DOI 10.1088/1742-6596/1515/2/022055](https://doi.org/10.1088/1742-6596/1515/2/022055)
25. S.Begmatov, D.Khalmanov, and others. AIP Conference Proceedings, **2552**, **040011**, (2022), <https://doi.org/10.1063/5.0130666>
26. K.Reymov, S.K.Makhmuthonov, G.Turmanova, and Q.Uzaqbaev. E3S Web of Conferences **289**, **07023**, (2021), <https://doi.org/10.1051/e3sconf/202128907023>
27. T.Gayibov, K.Reymov, and A.Aytbaev. E3S Web of Conferences **289**, **07024**, (2021), <https://doi.org/10.1051/e3sconf/202128907024>