

Dimensional characteristics of grist intermediate products obtained in the first two technological passages in the reduction phase of an industrial milling plant

Gabriel-Alexandru Constantin¹, Gheorghe Voicu¹, Elena-Madalina Stefan^{1,*}, Mariana-Gabriela Munteanu¹, Gabriel Musuroi¹, and Iulian Voicea²

¹Politehnica University of Bucharest, Faculty of Biotechnical Systems Engineering, Romania

²The National Institute of Research – Development for Machines and Installations Designed for Agriculture and Food Industry – INMA Bucharest

Abstract. After the wheat is coarsely grinded in the breakage technological phase and after a certain percentage of flour and bran has been extracted here, the crushing is continued in the reduction technological phase. The paper presents the flow of grist products at the first two technological passages from the reduction phase of an industrial milling unit. Samples taken from these two technological passages were subjected to a granulometric analysis, and with the experimental data a nonlinear correlation was performed with the Rosin-Rammler law, obtaining correlation coefficients of over 0.954. The paper also discusses the limits of the dimensions between which the particles of each fraction are sorted at the first two technological passages in the reduction phase. The analysis performed in this paper can serve in establishing the fabrics of the sifting frames from the plansifter compartments, respectively when adjusting the roller mills.

1 Introduction

Among the grains, wheat (*Triticum aestivum*) is the second largest production level in the world, most of which being subjected to a process of grinding and turning into flour [1, 2], in the first place being corn, while in third place is rice (for grinding). Wheat is the only cereal with enough gluten content, from whose flour ordinary bread can be obtained without being mixed with other types of flour [3].

The modern roller milling process of wheat can be divided into three main systems: break system, where grist fractions are passed through a series of fluted break rolls and the various resulted milling fractions are separated by being passed through a plansifter compartments; the grading system, where the particles are separated from sizes and endosperm particles are separates from adhering bran; reduction system which reduce pure

* Corresponding author: stefanelenamadalina@gmail.com

endosperm to fine particles of flour by passing through a series of smooth grinding rolls [4 - 6].

The grinding process takes place continuously, by gradually passing the material from machine to machine, in order to obtain flour, semolina and bran. The main machines used in a milling unit are: roller mills (break system and reduction system), plansifter, semolina machine and bran finisher (grading system). Thus, the two principal operations in milling process are grinding and sifting, [6,]. Several technological passages are provided for two phases of grist breakage and reduction, passages that consists in a grinding the same product on one or more rolls pairs followed immediately by sifting in one or more plansifter compartments. The technological diagrams for grinding wheat have in composition, mainly, several breakage technological passages and several reduction technological passages. In the breakage phase are used grinding rolls with flutes, while in the reduction phase the grinding rolls have a smooth surface.

The optimization of the milling processes (reduce energy costs, yield flour, improve quality) requires understanding the behaviour of materials, the material circuit on the technological flow, and machine operations [6]. The factors affecting the milling process and the end-product quality are machines type, the machine operational parameters, and the material properties, as described in papers [7 - 11]. Flour from different grinding passage differ significantly in terms of chemical composition and physical properties [12]. In papers [12, 13] it is shown that at the first two reduction passages was obtained the highest yield in flour with a minimum ash content, but also of the highest quality, the best quality bread was obtained from them. As has been shown in numerous papers [11, 14, 15], the material obtained at the first passage of the reduction phase is composed of endosperm and endosperm with particles of bran adhering. The bran particles are flattened and remain in the coarsest size fractions ($>200 \mu\text{m}$), which favours the process of separating the endosperm particles from the flour particles.

Modern wheat grinding is an efficient technological process that economically splits wheat seeds to recover high quality flour. The endosperm is the main part of the seed, being composed of about 64-75% starch, 11-16% protein, 1.5% fat, 0.5% minerals, 1.5% dietary fibre, and other components, [16].

In the process of dry grinding, especially in the last breakage and reduction passages, an increase in the content of Alternaria-type toxins was detected, which is mainly concentrated in the peripheral layers [1]. For this reason, first quality flour, which is extracted from the central parts of the core, can be considered safer than inferior quality flour or than milling by-products.

Also, Hajnal et al. [1] shows that fine wheat particles from breakage passages IV, V and VI or those from the last reduction passages lead to dark flour, with lower quality, with a high mineral content (ash). It seems that the by-products have a weight of about 17-24% (bran and short fractions), the dominant share being the big bran (walloping, 14-15%).

In the grinding process, starch granules can be damaged, especially in durum wheat where the starch-protein bonds are stronger, compared to common wheat which bonds are weaker. The aleuronic layer, surrounding the endosperm, having cells overgrown with it, but with strong ties with seed coat, it is difficult to extract in the grinding process, that is why he is largely removed with the brans. If aleuronic layer is included in the flour, the nutritional quality of the flour may increase, but the process requires special care so that the bran does not reach in the flour with the aleuronic particles [1, 4, 17].

The paper analyses the dimensional characteristics of the grist intermediate products from the first two technological passages in the reduction phase of a milling unit of 4.2 t/h.

2 Material and method

Grist samples were taken from S.C. Spicul S.A., Roşiorii de Vede, Romania, for the first two technological passages from the reduction technological phase. Thus, samples were taken from the grist mixture that feeds the two smooth grinding rolls (M1A and M1B), from the mixture that feeds the two plansifter compartments of the first two passages (C1 and C2), but also samples from the fractions sorted inside the two plansifter compartments. The technological flow of the semolina reduction phase is presented in figure 1. The equivalence between the number of the sieve and the dimensions of its apertures, are presented in standards and in paper [18].

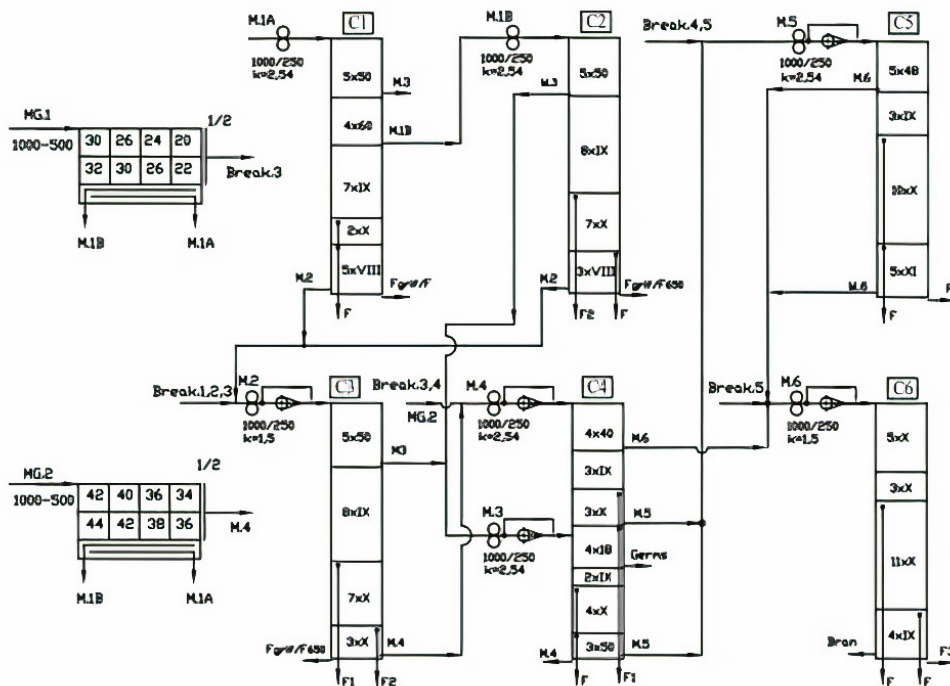

Fig. 1. Technological flow of semolina reduction phase, [19]. C1–C6 – plansifter compartments; Break 1–5 – breaking rolls; MG1, MG2 – semolina machines; M1A, M1B, M2–M6 – reduction rolls; F – F3 – flour.

It can be seen from Figure 1 that all grinding rolls of the reduction technological phase have a length of 1000 mm and a diameter of 250 mm and a smooth surface, without flutes. The ratio of the angular velocities of the grinding rolls is, for five pairs of reduction rolls, $k=2.54$, and for two pairs of reduction rolls $k=1.5$. This is contrary to the recommendations in the literature, which says that at reduction $k = 1.5$ or $k = 1$.

The products to be grinded in the reduction technological phase are products that arrive from the breakage technological phase (Break 1-6) or from semolina machines and bran finishers. Undersized particles from semolina machines, representing semolina that have dimensions below 1.0 mm, are grinded in the first two technological passages (roller mill M1A and plansifter compartment C1, and roller mill M1B and plansifter compartment C2). In diagram, the first fractions (an oversized fractions) sorted in the plansifter compartments of M1A and M1B technological passages are led to the grinding roll M3, which works together with a half of plansifter compartment (half from C4). It should be noted that in grinding rolls that crush smaller endosperm particles (about 0.40 mm), after the grinding

rolls are introduced into the technological flow material detachers, due to agglomerations that occur by compressing smaller endosperm particles in the area of action of the grinding rolls.

Semolina fractions grinded at reduction roll M1A are sorted on dimensional fractions inside the C1 plansifter compartment. This compartment consists of five sifting frames packages of metal or plastic fabric.

From Figure 1 it can be seen that the first five sifting frames (with fabric No. 50) are arranged in a package. The oversized particles collected from this package is sent to grinding roll M3, and the undersized particle feed the second package, consisting, in turn, of four sieve frames (No. 60). The oversized particles from this package is sent to grinding roll M1B, and the undersized particle feed the third package. It consists of seven sieve frames with 0.17 mm fabric apertures (flour sieve - no. IX). Fourth package of sifting frames (no. X) has two frames with plastic fabric with 0.15 mm apertures. The undersized particles collected from sifting frames of packages three and four from this compartment are discharged as a flour, and the oversized particles feed the last sifting package of compartment, which has five frames no. VIII (0.18 mm apertures width). The undersized particles from this package is a semolina flour that is discharged as such. The oversized particles are redirected for grinding to reduction roll M2.

After grinding at reduction roll M1B, the semolina is sorted into dimensional fractions in the C2 plansifter compartment, consisting of 4 packs of frames. The first package has five frames with fabric no. 50, at the end of which the first fraction of oversized particles is directed to the grinding roll M3. The undersized particles from this package feeds the second package consisting of eight flour frames no. IX. In turn, the undersized particles of the second package is discharged in the form of flour (F2), having particles smaller than 0.17 mm. The oversized particles from this package is directed to the third package consisting of seven frames of flour sieve no. X which evacuates the undersized particles as flour. The oversized particles of this package reaches the first of the three frames of the last package of the compartment (with fabric no. VIII). The oversized particles of the fourth package is directed for re-grinding to the grinding roll M2, and the undersized particles are extracted in the form of semolina flour.

After sampling on the flow of the milling unit, in the laboratory 100 grams of material was subjected to a particle size analysis with a classifier with sieves Analysette 3 Spartan type, the fineness of the fraction being appreciated by the mean diameter of the grist particles:

$$d_m = \frac{\sum p_i \cdot d_i}{\sum p_i}, mm \quad (1)$$

where: p_i - the percentage of material on sieve i of the classifier; $\sum p_i = 100$ – the sum of the percentages of material on the sieves; d_i – the mean particle size of each fraction, considered as the arithmetic mean of the size of the apertures of the sieves enclosing the respective fraction $d_i = (x_i + x_{i+1})/2$.

The grist samples (14 in number) were sorted by sifting on a set of 5 superimposed sieves driven in vibrating motion with an amplitude of 2 mm, the sifting time being 3 minutes. The working methodology is presented in numerous papers in the literature, [20, 21].

The experimental data were subjected to a nonlinear regression analysis, in Microcal Origin. It were thus obtained, variation curves for sifted T (x) and for rejected material, R (x). Nonlinear regression analysis was performed using Rosin-Rammler particle size distribution law, [22, 23], and which is represented by relationships:

$$T(x) = 100 \cdot \left(1 - e^{-\alpha x^\beta}\right) \quad (2)$$

$$R(x) = 100 \cdot e^{-\alpha x^\beta} \quad (3)$$

where $T(x)$ – represents the mass percentage weight of the fraction with particles smaller than x (passed through the sieve with size x), and $R(x)$ – mass percentage by weight of the fraction with particles larger than x (which do not pass through the sieve with dimension x); x – the size of the sieve apertures; α and β – nonlinear regression coefficients.

3 Results and discussions

In table 1 is shown the results of the particle size analysis for the grist that feeds grinding roll M1A, and is then sorted in the plansifter compartment C1 (see figure 1) and the dimensions of the sieve apertures used in the classifier.

Table 1. Weight values p_i (%) of the fractions on the classifier sieves and of the cumulative weights T_i (%) for products collected at the inlet and at the 5 outlets of the plansifter compartment of the first technological passage, but also for the fraction that feeds the grinding roll M1A.

	M1A Entr.		x		C1 Entrance		x		C1M3		x		C1M1B		
	(mm)	p(%)	T(%)	(mm)	p(%)	T(%)	(mm)	p(%)	T(%)	(mm)	p(%)	T(%)	(mm)	p(%)	T(%)
0	0.000	0.90	0.00	0.000	34.40	0.00	0.000	0.10	0.00	0.000	0.40	0.00	0.000	0.40	0.00
1	0.180	1.00	0.90	0.180	16.30	34.40	0.100	0.30	0.10	0.100	7.90	0.40	0.100	7.90	0.40
2	0.250	3.70	1.90	0.250	10.30	50.70	0.125	19.40	0.40	0.125	8.70	8.30	0.125	8.70	8.30
3	0.315	33.30	5.60	0.315	15.80	61.00	0.180	50.80	19.80	0.180	30.70	17.00	0.180	30.70	17.00
4	0.500	49.10	38.90	0.500	12.50	76.80	0.250	25.50	70.60	0.250	45.30	47.70	0.250	45.30	47.70
5	0.710	12.00	88.00	0.710	10.70	89.30	0.315	3.90	96.10	0.315	7.00	93.00	0.315	7.00	93.00
d_m	$d_{M1A,E} = 0.55$			$d_{1E} = 0.33$ mm			$d_{1M3} = 0.23$ mm			$d_{1M1B} = 0.24$ mm					

	x		C1M2		x		C1F		x		C1Fgrif	
	(mm)	p(%)	T(%)	(mm)	p(%)	T(%)	(mm)	p(%)	T(%)	(mm)	p(%)	T(%)
0	0.000	0.20	0.00	0.000	1.30	0.00	0.000	0.60	0.00	0.000	0.60	0.00
1	0.063	4.20	0.20	0.090	35.30	1.30	0.063	9.30	0.60	0.063	9.30	0.60
2	0.090	10.10	4.40	0.125	17.50	36.60	0.090	25.70	9.90	0.090	25.70	9.90
3	0.125	33.50	14.50	0.160	22.90	54.10	0.125	38.60	35.60	0.125	38.60	35.60
4	0.160	40.70	48.00	0.180	15.60	77.00	0.160	20.10	74.20	0.160	20.10	74.20
5	0.180	11.30	88.70	0.200	7.40	92.60	0.180	5.70	94.30	0.180	5.70	94.30
d_m	$d_{1M2} = 0.16$ mm			$d_{1F} = 0.15$ mm			$d_{1Fgrif} = 0.17$ mm					

Analysing figure 1 it can be seen that the M1A grinding roll is fed with part of the undersized particles of the two semolina machines (MG1 and MG2) from reduction phase. This mixture of particles that feeds the first grinding roll has most of the particles with dimensions greater than 0.25 mm (98.1 %) and generally represent the categories of semolina (great semolina – 12%, medium semolina – 49.1 % and small semolina – 33.3%) and harsh dunsts– 3.7 %. After grinding, the mixture obtained (fraction C1 Entrance) it will be fed into the plansifter compartment C1 for separation on particle size fractions. After grinding, the percentage of particles larger than 0.25 mm decreases from 98.1% to 49.3% and represents the same categories as above (great semolina – 10.7%, medium semolina – 12.5 %, small semolina – 15.8% and harsh dunsts – 10.3 %). In this mixture there are also particles with dimensions below 0.18 mm (about 34.4%) mainly represented by the C1F and C1Fgrif grist fractions. The resulting fractions, which are sorted at compartment C1, have mean particle sizes corresponding to Table 1. It can also be seen that if the mean diameter of the particle mixture being fed into the M1A grinding roll is 0.55 mm, immediately after grinding the average diameter decreases by 0.22 mm for the fraction that will feed the plansifter compartment C1 (C1 Entrance).

The fraction C1M3 represents an oversized particles fraction with a high coating content. The mean particle size for C1M3 is 0.23 mm, but within this fraction about 80.2%

of the particles have dimensions of more than 0.18 mm. This fraction re-enters the grinding process at the M3 reduction roll.

The fraction C1M1B, also a refuse (of the second frames package), has an mean particle size of 0.24 mm, with a percentage of more than 83% from particles larger than 0.18 mm. The representative category for this mixture of particles is that of dusts. So, about 50% of these particles are harsh dusts, and the remaining about 33% are fine dusts. This fraction is combined with the remaining undersized particles from the semolina machines and, together, re-enters the grinding process at the M1B grinding roll.

The third fraction is also a refusal (of the last package of frames), from the category of dusts-type products, have 11.8% particles larger than 0.18 mm. Having an average particle size of 0.16 mm, is grinded in the M2 reduction roll of the milling unit.

The two flours extracted in the compartment (the undersized particles from packages 3, 4 and 5) have an mean particle size of 0.15 mm (C1F), respectively 0.17 mm (C1Fgrif). Fraction C1F is extracted as an undersized particles fraction of packages 3 and 4 and has 63% of particles larger than 0,125 mm. Fraction C1Fgrif is a semolina flour and has most of the particles (over 64%) larger than 0.125 mm.

Table 2. Weight values p_i (%) of the fractions on the classifier sieves and of the cumulative weights T_i (%) for products collected at the inlet and at the 5 outlets of the plansifter compartment of the first technological passage, but also for the fraction that feeds the grinding roll M1B.

	x (mm)	M1B Entr.		x (mm)	C2 Entrance		x (mm)	C2M3		x (mm)	C2M2	
		p(%)	T(%)		p(%)	T(%)		p (%)	T(%)		p(%)	T(%)
0	0.000	0.40	0.00	0.000	7.70	0.00	0.000	1.70	0.00	0.000	3.00	0.00
1	0.130	0.60	0.40	0.125	8.00	7.70	0.090	3.00	1.70	0.045	4.80	3.00
2	0.180	3.90	1.00	0.180	23.80	15.70	0.125	27.00	4.70	0.063	5.10	7.80
3	0.250	22.10	4.90	0.250	35.60	39.50	0.180	21.20	31.70	0.090	20.90	12.90
4	0.315	48.90	27.00	0.315	21.90	75.10	0.200	37.40	52.90	0.125	55.80	33.80
5	0.400	24.10	75.90	0.450	3.00	97.00	0.250	9.70	90.30	0.160	10.40	89.60
d_m	$d_{M1B.E} = 0.36$			$d_{2E} = 0.26$ mm			$d_{2M3} = 0.20$ mm			$d_{2M2} = 0.13$ mm		

	x (mm)	C2Fgrif		x (mm)	C2F2		x (mm)	C2F	
		p(%)	T(%)		p(%)	T(%)		p(%)	T(%)
0	0.000	3.60	0.00	0.000	39.10	0.00	0.000	10.40	0.00
1	0.045	8.80	3.60	0.090	20.60	39.10	0.045	22.90	10.40
2	0.063	10.60	12.40	0.125	30.30	59.70	0.063	17.60	33.30
3	0.090	18.50	23.00	0.160	5.20	90.00	0.090	29.60	50.90
4	0.125	53.10	41.50	0.180	3.50	95.20	0.125	18.40	80.50
5	0.180	5.40	94.60	0.200	1.30	98.70	0.160	1.10	98.90
d_m	$d_{2Fgrif} = 0.13$ mm		$d_{2F2} = 0.10$ mm		$d_{2F} = 0.09$ mm				

In table 2 is shown the results of the granulometric analysis for the fraction that feeds grinding roll M1B, and is then sorted in the plansifter compartment C2 and the dimensions of the sieve apertures used in the classifier.

Grinding roll M1B is, also, fed with the other part of the undersized particles from the two semolina machines (MG1 and MG2) from the reduction phase but also with the second refusal of compartment C1. This mixture of particles feeding the second grinding roll has most 95.1 % from particles larger than 0.25 mm. In generally, this particles represent the categories of dusts (harsh dusts- 70% and fine dusts – 5 %) but small semolina particles are also found – 24.1%. After grinding, the mixture obtained (fraction C2 Entrance) it will be fed into the plansifter compartment C2 for separation on particle size fractions. After grinding, the percentage of particles larger than 0.18 mm decreases from 99% to 84.3% and represents particles in the categories small semolina – 5%, harsh dusts – about 46 % and fine dusts - about 33%. In this mixture there are also particles with dimensions below 0.18 mm (about 15.7%) represented mainly, by the fractions C2F, C2F2 and C1Fgrif. It can be

seen that if the mean diameter of the particle mixture that is fed into the M1B grinding roll is about 0.36 mm, immediately after grinding the mean diameter decreases by 0.10 mm for the fraction that will feed the plansifter compartment C2 (C2 Entrance).

First fraction extracted from compartment C2 (C2M3) represents a refusal (oversized particles) with a mean particle size of 0.20 mm, 68.3% of the particles from this fraction have dimensions over 0.18 mm, and re-enters the grinding process at the M3 reduction roll.

The fraction C2M2 is also an oversized fraction and have a mean particle size of 0.13 mm, This fraction have more than 10 % of particles larger than 0.18 mm and has a high endosperm content.

The three flours extracted in the compartment have a mean particle size of 0.13 mm (C1Fgrif), 0.10 mm (C2F2) and 0.09 mm (C1F) respectively. 58.5% from C2Fgrif fraction particles (which is a semolina flour) is larger than 0.125 mm, compared to the C2F2 fraction which has 40% in the same range and reaches 19% within the C2F fraction.

In table 3 are presented the values of the coefficients α and β of the Rosin-Rammler distribution function, and the correlation coefficient R^2 , values obtained from nonlinear regression analysis.

Table 3. Values of the coefficients α and β of the Rosin-Rammler distribution function, and the correlation coefficient R^2

Fraction Coefficient	M1A Entrance	C1 Entrance	C1M3	C1M1B	C1M2	C1F	C1Fgrif
	$R(x), T(x)$	$R(x), T(x)$	$R(x), T(x)$	$R(x), T(x)$	$R(x), T(x)$	$R(x), T(x)$	$R(x), T(x)$
α	0.018	0.088	0.001	0.002	$1 \cdot 10^{-5}$	$4 \cdot 10^{-4}$	$6 \cdot 10^{-6}$
β	-5.702	-1.468	-5.149	-4.124	-5.813	-3.843	-5.773
R^2	0.998	0.997	0.998	0.978	0.981	0.975	0.991
Fraction Coefficient	M1B Entrance	C2 Entrance	C2M3	C2M2	C2Fgrif	C2F2	C2F
	$R(x), T(x)$	$R(x), T(x)$	$R(x), T(x)$	$R(x), T(x)$	$R(x), T(x)$	$R(x), T(x)$	$R(x), T(x)$
α	$9 \cdot 10^{-4}$	0.006	$1 \cdot 10^{-5}$	$4 \cdot 10^{-9}$	$1 \cdot 10^{-7}$	$3 \cdot 10^{-4}$	0.002
β	-6.301	-3.474	-6.716	-9.277	-7.503	-3.339	-2.367
R^2	0.999	0.986	0.997	0.982	0.954	0.985	0.981

As can be seen from the charts presented in figure 2, the majority of particles for some fractions have dimensions close to the min. value of sieves apertures. Other fractions have particles with mean dimensions close to the max. value of the sieve apertures. The experimental points are arranged to the left or right of the curve. At the same time, it can also be observed that the meeting point for the two particle size curves is rather towards the sieve with larger apertures. We refer here to the sieves used in particle size analysis.

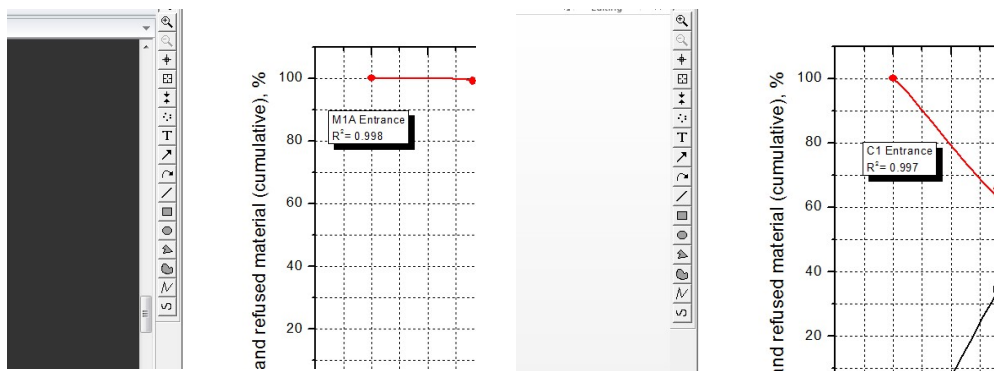

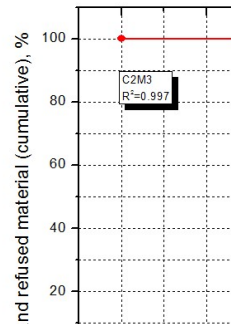
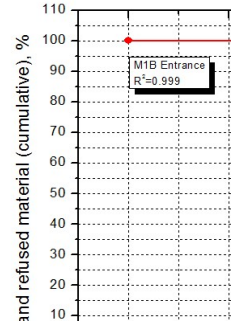
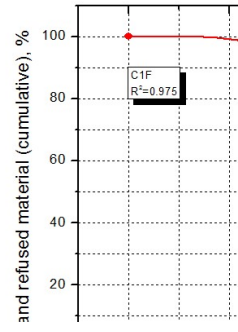
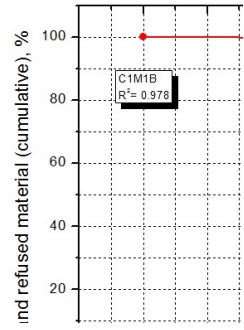
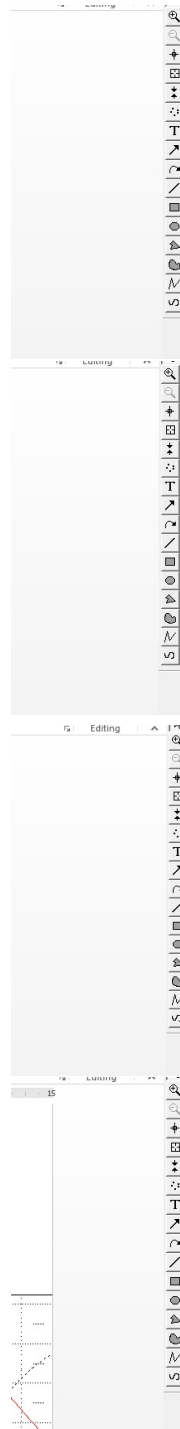
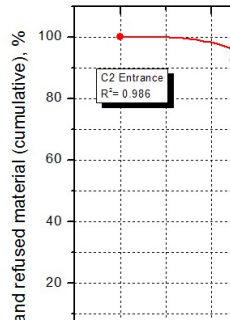
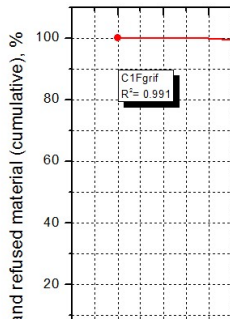
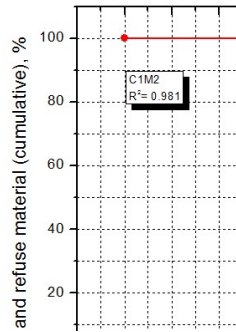
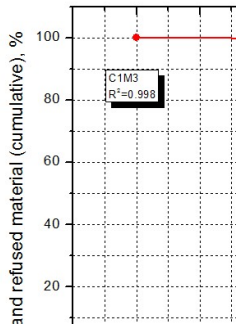

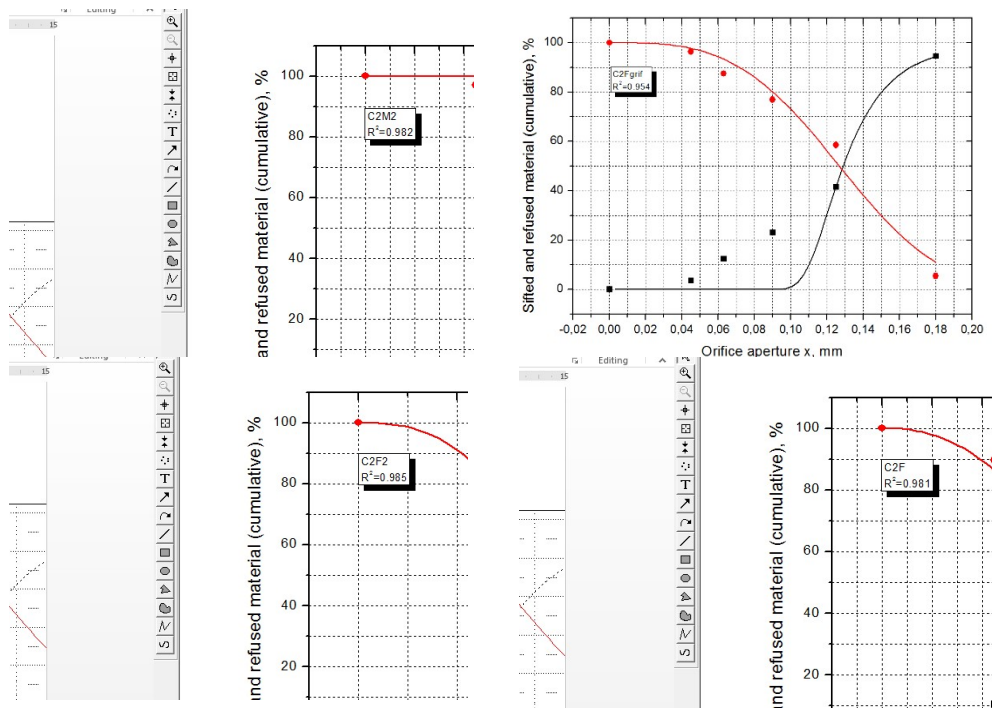

Fig. 2. The particle size distribution curves given by Rosin-Rammler relations;
 — - R(x); — - T(x)

The shape of the regression curves is correlated with the data from experiments. This shape depends on the weight of grist collected on the sieves used in the classifier for the particle size analysis.

4 Conclusions

For the two technological passages of the reduction phase analysed in this paper, we can say that the Rosin-Rammler law represents very well the experimental data, the correlation coefficient being of $R^2 \geq 0.954$.

The degree of non-uniformity for the grist particles fractions is indicated by β coefficient from the Rosin-Rammler equations. Form table 3 we can see that its values fall in a rather narrow range. This means that the fractions analysed were uniform, in terms of particle size.

The Rosin-Rammler law used in the paper shows (for the 14 grist fractions analysed) a very good correlation with the experimental. Knowledge of the mean dimensions and size distribution, and the other physical characteristics of the grist fractions are also requirements for adjusting the machines from the flow, and in choosing the fabrics of the sieves from plansifter compartments, from the input to the compartment to the output.

The paper was funded from the project „ *Improving the base of practical applications in solariums, gardens, orchards and vineyards (IMPRASGLIV)*” CNFIS-FDI-2021-0021, from the Ministry of Education through the Executive Agency for Financing Higher Education, Research, Development and Innovation.

References

1. E.J. Hajnal, J. Mastilović, F. Bagi, D. Orčić, D. Budacov, J. Kos, Z. Savic, Toxins, 11, 139, (2019);
2. *** www.statista.com;
3. V. Kanojia, N.L. Kushwaha, M. Reshi, A. Rouf, H. Muzaffar, International Journal of Chemical Studies, 6(4), (2018);
4. G.M. Campbell, C. Fang, I.I. Muhamad, Food Bioprod Process, 85, (2007);
5. G.M. Campbell, *Roller Milling of Wheat, Handbook of Powder Technology*, Vol. 12, (Science Direct, 2007);
6. G. Owens, *Cereals processing technology*, (Woodhead Publishing Ltd., (2001);
7. Q. Fang, E. Haque, C.K. Spilman, P.V. Reddy, J.L. Steel, Transaction of the ASAE, 41(6), (1998);
8. C. Fang, G.M. Campbell, Journal of Cereal Science, 37, (2003);
9. P. Guritno, E. Haque, Transactions of the ASAE, 37(4), (1994);
10. G.M. Campbell, P.J. Bunn, C. Webb and S.C.W. Hook, Powder Technology 115 (2001);
11. M. G. Scanlon, J. E. Dexter, Cereal chemistry, 63, (1986);
12. G. Cacak-Pietrzak, A. Sułek, M. Wzyńska, Agricultural Science, Research for Rural Development, 2, (2019);
13. S. D. Sakhare, A. A. Inamdar, J Food Sci Technol, 51(4), (2014);
14. A.K. Zaalouk, F.I. Zabady, Journal Ag.Eng. 26(1), (2009);
15. A. Z. Fišteš and M. Đ. Vukmirović, APTEFF, 40, (2009);
16. S.P. Galindez Najera, *A compositional breakage equation for first break roller milling of wheat*, University of Manchester – CEAS, PhD thesis, (2014);
17. G.M. Campbell, C. Sharp, K. Wall, F. Mateos-Salvador, S. Gubatz, A. Huttly, P. Shewry, Journal of Cereal Science, 55(3), (2012);
18. G.A. Constantin, *Researches on the sifting and sorting process of grist fractions in a industrial milling plant*, Doctoral thesis, “Politehnica” University of Bucharest, (2014).
19. Gh. Voicu, S.S. Biriş, E.M. Ştefan, G.A. Constantin, N. Ungureanu, *Grinding characteristics of wheat in industrial mills. Chapter 15 in Food Industry Book, Edited by InTech Europe*, (University Campus STeP Ri, 2013);
20. T. Căsândroiu, Gh. Voicu, G.D. Ţuţuianu, Proceeding of ISBTeh-2002 Conference, (2002);
21. Gh. Voicu, T. Căsândroiu, G.D. Ţuţuianu. Proceedings International Symposium „Euro-Aliment 2003”, (2003);
22. V. Headley, H. Pfost, Transactions of the ASAE, 11 (3), (1968);
23. S. Henderson, Hansen R., Transactions of the ASAE, 11 (3), (1968).