

Enhancement of the technology of mining steep ore bodies applying the “floating” crown

Serhii Pysmennyi^{1*}, Serhii Chukharev², Kyelgyenbai Khavalbolot³, Iryna Bondar¹, and Jambaa Ijilmaa³

¹Kryvyi Rih National University, 11 Vitalii Matusevych Str., Kryvyi Rih, 50027, Ukraine

²National University of Water and Environmental Engineering, Department of Development of Deposits and Mining, 11 Soborna Str., Rivne, 33028, Ukraine

³Mongolian University of Science and Technology, Baga Toiruu 34, Sukhbaatar, 210646, Mongolia

Abstract. When mining ore bodies in Kryvyi Rih iron ore basin, underground mines apply open stoping or bulk caving systems in proportion of 55% to 45%. Most of underground mines prefer stoping with pillar caving. Yet, rock pressure contributes to growth of costs for workings maintenance and deterioration of extraction indices. Rock mass extraction indices can be enhanced by application of a protective structure in the upper part of the block that will enable additional decrease in load on the draw level. There are a great many of methods for determining parameters of constructive elements of the protective structure that help keep its integrity for the whole period of block mining. The article suggests methods for determining parameters of the protective structure when mining steep ore bodies. The research conducted demonstrates that with the inclined protective structure, increase of unit load on it from 200 to 1200t/m² leads to decrease of its thickness from 6.3-20.9m to 5.5-18.4m and increase of the crown length from 40m to 60m. The developed block caving system with application of the protective structure when mining steep ore bodies enables overall decrease of ore dilution in the block by 3%, increase of iron content in the mined ore by 1.3% without significant mining costs growth and decrease of loads on the workings of the receiving level.

1 Introduction

Ore bodies of Kryvyi Rih iron ore deposit (Ukraine) house over 30.2 Bt of ferruginous quartzite with iron content of 24-65% [1-4]. These ore bodies are mined applying surface and underground methods. Underground methods are used to mine rich iron ores with iron content of 57–65% applying stoping systems and bulk caving of ore and overlying rock in proportion of 55% to 45% [5-8]. Most of underground mines prefer stoping with pillar caving. Yet, in complicated mining and geological conditions rock pressure contributes to growth of workings maintenance costs and deterioration of extraction indices [9-12].

Underground mining operations have reached the depth of 1350 m. Ore bodies stretch for 800-1200 m, their horizontal thickness is 30–120 m and the angle of slope is 45–85 degrees [13-16]. The authors of [17-20] state that ore bodies significantly differ from each other in not only physical and mechanical properties that influence mining and processing technologies but also their quality. Mining of agglomerated iron ores is the main type of activities of enterprises that are engaged in underground mining of naturally rich iron ores. In compliance with specifications, agglomerated ores are produced at grinding-sorting complexes of underground mines through grinding at several stages, screening and blending at surface stockpiles [21-25].

To enhance indicators of the final product, concentration complexes apply various technologies and methods of controlling the process of concentrating crude ore considering energy-efficiency indicators [26-29]. To settle resource saving issues, a modern complex approach of controlling environmental-economic systems applying the theory of administrative-engineering management is used. Yet, this results in increased mining costs and alienation of land for concentration waste storage.

When mining ore bodies in complicated mining and geological conditions, ore losses and dilution become higher by 3-5% as compared with the standards. Increased losses and dilution result in pre-schedule mining-out of the level, increased volumes of capital mining operations and ore mining costs [30-33].

The authors of [33-38] suggest various options of mining ore bodies that enable enhancement of ore mass extraction from stopes. However, rock pressure may lead to stope failures when forming a compensation space and, consequently, result in deterioration of extraction indices, decrease of labour efficiency and increase of time spent on mining a block.

At Kiruna mine, application of the bulk caving system without considerable exposures enables enhancement of ore extraction indices in unfavorable mining and geological conditions [39, 40]. Managers of Kryvyi Rih underground mines have made several attempts to implement the system. However, this has resulted in

* Corresponding author: psvknu@gmail.com

deterioration of labour conditions and increased mining costs due to complicated mining and engineering conditions (instable fractured ore and rocks).

To enhance extraction indices, the sublevel caving system with an artificial flexible metal layer was applied to extract polymetal ores at Bakyrchik mine (Kazakhstan). The developed option with a flexible metal layer in the upper part of the block and longhole blasting (Fig. 1) has proved to be efficient despite considerable economic indices of mining [41-43].

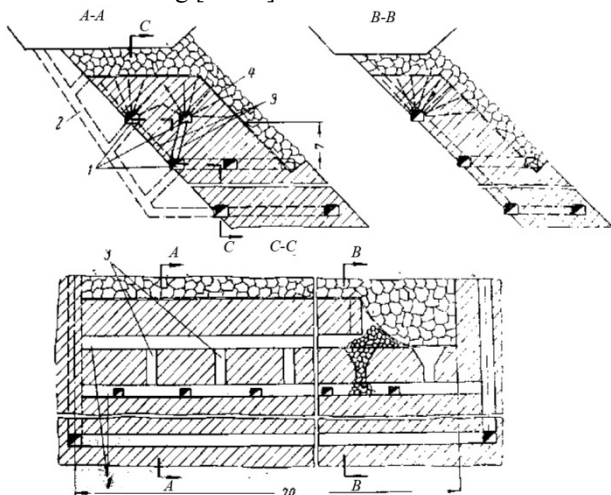

Fig. 1. Ore mining under a flexible layer: 1 – drill sublevel drifts; 2 – orepass; 3 – box raises; 4 – the flexible layer.

It should be noted that application of this mining system requires that flexible roofing should be sufficiently strong and withstand not only static but also dynamic loads when stoping. It has proved to be not only protecting against caved rock coming into the face space but also a load bearing support that creates safe working conditions.

The state research ore mining institute “SkhidNDGRI” has suggested the option for mining blind ore bodies with drawing the broken ore under the protective rock block-shield that separates caved rock and ore [44] (Fig. 2).

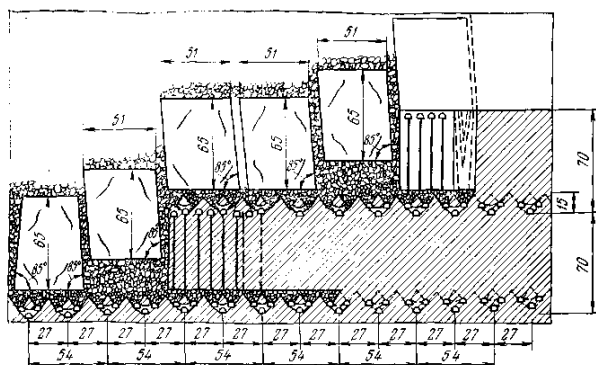

Fig. 2. The system of induced block caving under the protective rock block-shield.

Kuznetsk metallurgical plant (Russia) has tested this technology at its mine. The experimental block was formed in the 10-20 m thick magnetite ore body with sulphide inclusions at the depth of 130-150 m. The stope was mined applying block caving with layered ore

breaking by a bunch of parallel contiguous boreholes on the “compressed environment”. The caved ore under the rock block-shield was drawn applying scraper equipment.

Geometry of the stope was as follows: length – 36 m; width – 16-20 m; height of the caved ore layer – 32.5 m; length of the block-shield – 30 m, distance between block-shields – 2.5-3 m. Ore massif was broken by 10-13 m wide parts bunches of parallel contiguous boreholes. The ore was drawn successively from drawpoints until the block-shield moved vertically for 13 m. Then the ore was drawn from the previously broken adjacent block. Application of this technology enabled high ore extraction indices [44].

Thus, the technology of mining blind ore bodies applying a block-shield is rather promising. Yet, its application is possible for steep ore bodies only.

The sublevel caving system with creation of rock and ore moving protective structure (the “floating” crown) is suggested to mine parallel contiguous steep ore bodies [45] (Fig. 3).

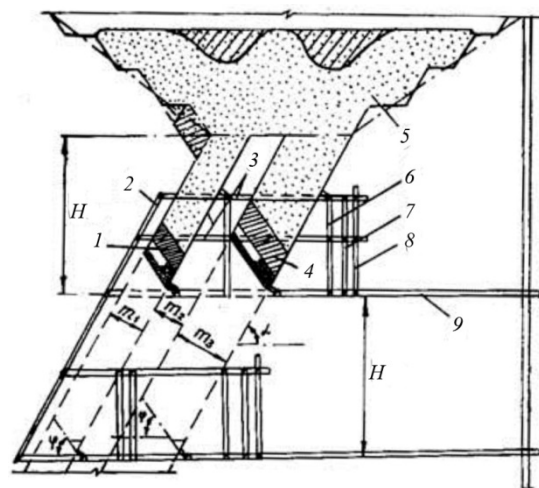

Fig.3. The flowsheet of forming “floating” rock and ore crowns (FC): 1, 4 – rock and ore FC; 2, 6, 7, 8 – ventilation, ore drawing, manway and service raises respectively; 3 – drilling sublevels; 5 – overburden rocks of the inside dump; 9 – the haulage level.

In this case, in the upper part of the stope, the FC is formed at a certain angle (Fig.3). To control vertical movements of the FC, a remote control circuit is developed. The authors suggest determining the FC thickness applying methods for defining structural elements of the room-and-pillar system for the inclined crown. Permissible dimensions of exposures and pillars are calculated depending on the level height and the FC thickness on the basis of methods developed by the research ore mining institute.

The FC is formed by drilling and blasting. Along the strike, the crown is formed from drill drifts of the footwall and the hanging wall with the help of short holes; across the strike – from a drill drift by longhole rings.

Ore stoping is performed until the FC is formed. For this, a drawing level is formed in the stope by a cut raise and the ore massif is caved by blasthole rings. After the mining block is filled with the broken ore, the FC is formed and the broken ore is drawn off from the stope

under the crown, vertical movement of the crown being controlled.

To provide even movement of the FC, caved ore should be controlled, especially while drawing from a series of drawpoints. For this, it is necessary to create a single drawing zone (one drawing crater 7 and a loosening zone 2, 8) in the center of the block (panel) as when drawing from a single drawpoint (Fig. 3).

Even vertical movement of the FC with its integrity preserved for the whole period of mining depends on the following factors: physical and mechanical properties of ore, the draw level parameters, overlying rock pressure on the FC.

According to [46-49], uniform sequential drawing of caved ore from adjacent drawpoints shifts the centers of both drawing figures and results in intensive formation of one drawing figure out of two [49] (Fig. 4).

In [48], the author states that in case of non-observance of the uniform advanced mode of drawing, there may be formed two or even three and more craters under the FC. This will result in significant losses and dilution due to the craters running beyond the protective structure, and in more complicated control over the even FC movement

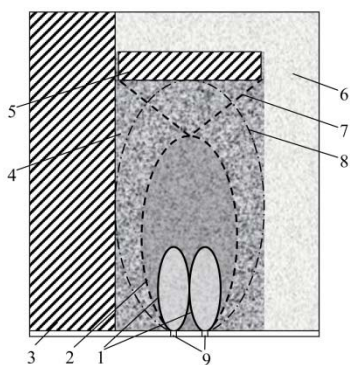

Fig. 4. Formation of drawing and loosening figures and a draw crater while drawing caved ore from a series of drawpoints: 1 – the drawing ellipsoid; 2 – the loosening ellipsoid; 3 – uncaved mass; 4 – caved ore; 5 – the FC; 6 – caved rocks; 7 – the draw crater; 8 – the loosening ellipsoid at the moment of reaching the FC; 9 – drawpoints.

To prevent the draw crater running beyond the FC, construction of the protective structure should be changed (Fig. 5). Thus, creation of the FC with protective brows in the lower part along its perimeter enables decreasing side dilution of the caved ore. Parameter of the protective brow are determined based on conditions of its formation (by drilling and blasting), compressive strength and the number of FC. The height of the protective brow (h_{br}) makes 3-5 m and it is determined by parameters of the drilling room.

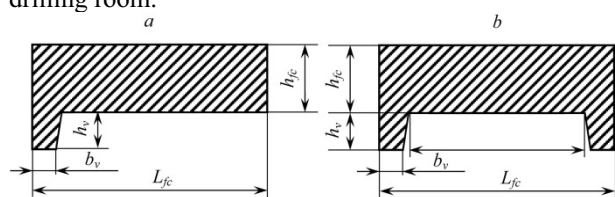

Fig. 5. The principle diagram of “floating crowns”: a – asymmetric “I”-shaped; b – symmetric “II” – shaped.

Thus, enhanced extraction indices can be achieved through separation of broken ore and caved rock by the protective structure [36, 39, 43].

2 Methods

Application of the protective structure in the upper part of the block enables redistributing of loads on the draw level and enhancing indices of caved ore extraction from the stope. However, there is no technology for mining steep ore bodies by bulk caving and applying the protective structure. Thus, research into and enhancement of the technology of stoping under high rock pressure remains actual.

The work aims to enhance the technology of mining steep ore bodies applying the moving protective structure in the upper part of the stope.

The task of the work consists in developing the technology able to provide increased iron content in mined ore mass in complicated mining and geological conditions.

3 Results and discussion

In underground mining, calculation of pillars between underground rooms and the open stoping space is of great interest. These pillars can be treated as crowns.

The widely used method of calculating the crown thickness is based on the rock fragmentation factor at caving. This method is used for low stopes. If stopes are high, thickness of crowns would be inexpediently great. There are a number of constraints considering which safe dimensions of crowns should be calculated on the basis of cave arch parameters. Height of the natural arch is known to depend on the working width and physical and mechanical properties of rocks. Despite all advantages of this method of calculating the safe FC thickness, it is insufficiently reliable due to the fact that in conditions of large roof exposures, determination of cave arch parameters is rather difficult [44]. At that, it is practically impossible to determine the moment when formation of the dome of equilibrium is finished.

To calculate the safe thickness of a crown, the most reasonable are the methods of structural mechanics that are described in recent scientific works [5, 6, 44-46]. The authors of the works recommend to distinguish among three types of crowns: *a* – a long thick beam-like plate constrained along the contour; *b* – a plate constrained along the contour and with fixed corners if its length-to-width ratio equals or exceeds six; *c* – a plate constrained along the contour and with fixed corners if its length-to-width ratio is less than six.

Crowns of various types can be calculated with insignificant errors using a unified methodology, this facilitating such calculations in production conditions. As mentioned above, the FC thickness depends on the exposure span, physical and mechanical properties and rock loads. Along with that, it should be taken into account that unreasoned increase of the FC thickness in order to raise the factor of safety leads to increased losses of the useful mineral.

The FC is treated as a separately structured plate-like part of the massif moving together with overlying rocks. According to the above mentioned, the width and the length of the FC are equal, so let us treat it as a plate resting on a moving support (“support pillars”) consisted of the caved ore and located near a draw crater. The FC undergoes loads from its weight and the weight of the caved rock [44, 45]. Bending moments in section points of the crown are calculated similarly to those for a plate freely abutting with its four sides. Stresses impacting the plate along the x-x and y-y axes are calculated by the expression

$$\sigma_x = \sigma_y = \frac{12M_{x\max}}{h_{fc}^3}z = \frac{12M_{y\max}}{h_{fc}^3}z, \quad (1)$$

where $M_{x\max}$, $M_{y\max}$ are values of the maximum bending moment in the z part of the span of the “floating crown” exposure along the x and y axes respectively; h_{fc} is the thickness of the “floating crown”, m; z is the distance on which the largest stresses occur in the plate, m.

According to [50]. The largest stresses occur at $z = \pm h/2$. That is why, stresses in the plate under load should satisfy the condition

$$\sigma_{x\max} = \sigma_{y\max} = \frac{6M_{x\max}}{h_{fc}^2} = \frac{6M_{y\max}}{h_{fc}^2} \leq [\sigma_p], \quad (2)$$

where $[\sigma_p]$ is the permissible tensile stress of rocks making the “floating crown”, t/m².

As the FC length and width are equal, expression (2) will look like

$$\sigma_{\max} = \frac{6M_{\max}}{h_{fc}^2} \leq [\sigma_p], \quad (3)$$

where M_{\max} is the total of bending moments in the middle part of the FC exposure span.

The value $[\sigma_p]$ in expression (3) is calculated as follows

$$[\sigma_p] = \frac{K_f f_p K_o}{K_z}, \quad (4)$$

where K_f is the coefficient of converting rock hardness into stress; f_p is the Protodyakonov hardness ratio of rock including those of the “floating” crown; K_o is the factor of rock loosening caused by fissures (assumed from 0.5 to 0.85); K_z is the safety factor of rocks of the “floating” crown (changing from 1.5 to 2.5).

When mining steep ore bodies, [45] suggests forming the FC not horizontally but at some angle to the receiving level.

The crown should be inclined at the angle that will not allow its turning over in the stope from the hanging wall side, i.e. the angle between the stationary crown and the hanging wall does not exceed 80 degrees (Fig. 6).

The minimal crown inclination angle α_{fc} for steep ore bodies is generalized by the expression, degrees

$$\alpha_{fc} = 100 - \alpha_w, \quad (5)$$

where α_w is the dip of the hanging wall rocks, degrees.

Formula (5) is true when the ore body dip changes from 40 to 80 degrees. Considering the fact that the FC is inclined, stress components will be redistributed

according to the expression

$$[\sigma_p] \sin \alpha_{fc} = \frac{K_f f_p K_o}{K_z}. \quad (6)$$

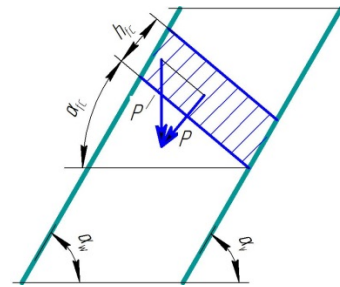

Fig. 6. The principle diagram of determining the FC formation angle.

Solving the equation (3) with respect to h_{fc} , we will obtain the general expression for determining the maximum permissible thickness of the “floating” crown

$$h_{fc} = \sqrt{\frac{6M_{\max} K_z \sin \alpha_{fc}}{K_f f_p K_o}}. \quad (7)$$

Taking into account independences of force actions, the value of the maximum bending moment is calculated as the total of moments of each load according to the expression

$$M_{\max} = M_{\max}^c + M_{\max}^p, \quad (8)$$

where M_{\max}^c и M_{\max}^p are values of the maximum bending moments on the span of the “floating” crown exposure depending on the weight of the crown itself and the weight of overlying rocks respectively.

The bending moment from the “floating” crown weight is determined as follows

$$M_{\max}^c = \beta_m P_{cr} l_{sp}^2 \gamma_o, \quad (9)$$

where β_m is the bending moment in the freely abutting plate (“floating” crown) equaling 0.0479 [50]; P_{cr} is the load caused by the weight of the crown on 1 m of its width, t/m²; l_{sp} is the span of the exposure under the “floating” crown, m; γ_o is the volumetric weight of the crown rock, t/m³.

Let us consider the FC lying on the caved ore as a plate [50]. The bending moment caused by the caved rock weight impacting the “floating” crown four sides of which rest on support pillars is described by the differential equation

$$\frac{\partial^4 \omega}{\partial x^4} + 2 \frac{\partial^4 \omega}{\partial x^2 \partial y^2} + \frac{\partial^4 \omega}{\partial y^4} = 0. \quad (10)$$

Task (10) is solved considering boundary conditions. If the crown abuts freely with its four sides is freely supported, the boundary conditions will look like (11), and the task is solved by numerical methods

$$\left\{ \begin{array}{l} \omega|_{x=0}^{x=a} = 0, \\ \frac{\partial^2 \omega}{\partial x^2} \Big|_{x=0}^{x=a} = 0, \end{array} \right. \text{ и } \left\{ \begin{array}{l} \omega|_{y=0}^{y=a} = 0, \\ \frac{\partial^2 \omega}{\partial y^2} \Big|_{y=0}^{y=a} = 0, \end{array} \right. \quad (11)$$

where a is the FC length (width), m.

As solution of equation (11) requires use of numerical methods which are cumbersome, the author of [50] suggests a simplified equation to determine the maximum bending moment in engineering calculations

$$M_{max}^P = C_1 P_{cr} l_{sp}^2, \quad (12)$$

where C_1 is the adjustment coefficient of bending moments, [50]; P_{cr} is the load of overlying rocks on 1 m of the FC width, t/m^2 .

Substituting the value of the bending moment calculated by formula (12) in expression (7), we obtain the final expression for determining the minimal permissible thickness of the FC

$$h_{fc} = 0,1437 l_{sp} \sqrt{\sin \alpha_{fc} \left(\frac{l_{sp} \gamma_o K_z}{K_f f_p K_o} + \frac{\sqrt{(l_{sp} \gamma_o K_z)^2 + 290,65 C_1 P_{cr} K_f f_p K_o K_z}}{K_f f_p K_o} \right)}. \quad (13)$$

Vertical movement of the FC occurs during caved ore drawing due to destruction of the support pillar which the crown rests on. Let us assume that at the angle of the support pillar rocks shear, the shearing and holding forces are in bounding equilibrium. So, stability of bounding equilibrium is described by Coulomb's law and looks like

$$\tau = \tau_o + \sigma_n \operatorname{tg} \rho, \quad (14)$$

where τ is the shearing stress in the support pillar, t/m^2 ; τ_o is the initial shear resistance which equals rock cohesion c at $\sigma = 0$, t/m^2 ; σ_n is the normal stress in the support pillar, t/m^2 ; ρ is the friction angle, degrees.

Normal and shear stresses are included in equation (14) and determined as follows

$$\sigma_n = \sigma \cos \theta, \tau = \sigma \sin \theta, \quad (15)$$

where σ is the effective value of the compacting stress, t/m^2 .

The compacting stress σ is the ratio of the total weight of overlying rocks (P_{rock}) and the "floating" crown (P_{cr}) to the total area of the "support" pillar cross section (S_{max}) [51-54]

$$\sigma = \frac{P_{rock} + P_{cr}}{S_{max}} = \frac{P}{S_{max}}, \quad (16)$$

where P_{rock} , P_{cr} are loads caused by overlying rocks the FC respectively, t ; S_{max} is the area of the cross section which the FC rests on, m^2 .

On solving (16) with regard to S_{max} , we obtain the formula for determining minimal permissible areas of the "support" pillar that bears the FC

$$S_{zp} = \frac{P(\sin \theta - \cos \theta \operatorname{tg} \rho)}{c}. \quad (17)$$

Then, when drawing ore from a series of drawpoints, the maximal exposure span under the "floating" crown is calculated by the formula

$$l_{sp} = 2 \sqrt{\frac{ca^2 - P(\sin \theta - \operatorname{tg} \rho)}{\pi c}}. \quad (18)$$

The research conducted enables the conclusion that

the exposure under the FC depends on physical and mechanical properties of ore and the effective load P that consists of the weight of the overlying rocks and the weight of the "floating" crown. In its turn, the weight of the "floating" crown depends on its constructive parameters (width, length and thickness).

Based on calculations of the crown thickness considering the FC inclination angle, the dependencies of the "floating" crown thickness on the unit load on the FC at the ore body dip of 60° are built (Fig. 7).

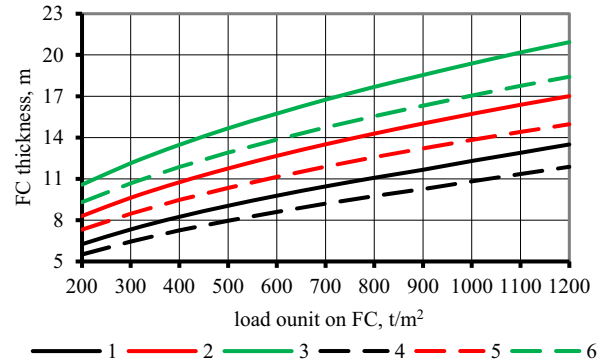

Fig. 7. Dependency of the "floating" crown on the unit load on the protective structure and its parameters at: 1, 2, 3 – the FC lengths of 40 50 and 60 m respectively at the angle of 0° ; 4, 5, 6 – the FC lengths of 40, 50 and 60 m respectively at the angle of 40° to the receiving level.

Fig. 7 demonstrates, that if the unit load on the FC increases from 3 200 to 1200 t/m^2 and the crown incline angle of 0° and 40° , the crown thickness grows from 6.3 to 20.9 m and to 5.5 to 18.4 m respectively. It should be noted that the character of crown thickness changes at the angles of 0° and 40° is similar. Thus, it can be concluded that calculations based on the enhanced methods provide reliable results.

The conducted research enables the conclusion that depending on the location of drawpoints, waste rock can get into the mining block. This happens when the caved ore is drawn under the FC inclined against the receiving level. (Fig. 8).

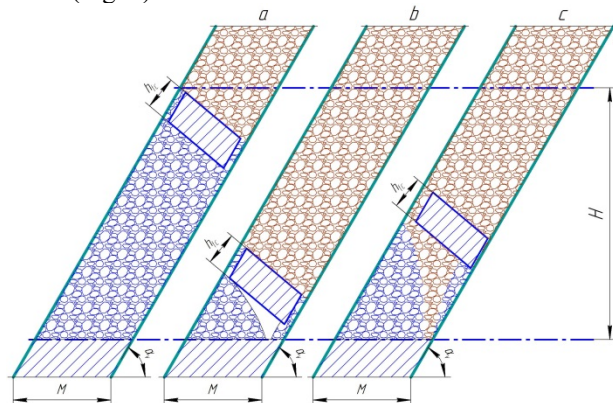

Fig. 8. Diagrams of the FC movements while ore drawing: a – the initial stage; b – the final stage of caved ore drawing; c – the final stage of caved ore drawing after the active drawing area moves beyond the protective structure.

Yu.P. Kaplenko and V.O. Kolosov state that after ore drawing from the stope, the FC will move as shown in Fig. 6b. However, according to S.V. Pysmennyi's research, the

drawing area moves beyond the FC with the 50% probability and lets waste rock into the active drawing zone (Fig. 8c). To prevent this, it is suggested to create protective brows in the lower part of the crown (see Fig. 5).

Analysis of caved ore drawing under the protective structure when mining steep ore bodies enables the conclusion that it is reasonable to locate protective brows in the upper part of the FC from the hanging wall side (Fig. 9).

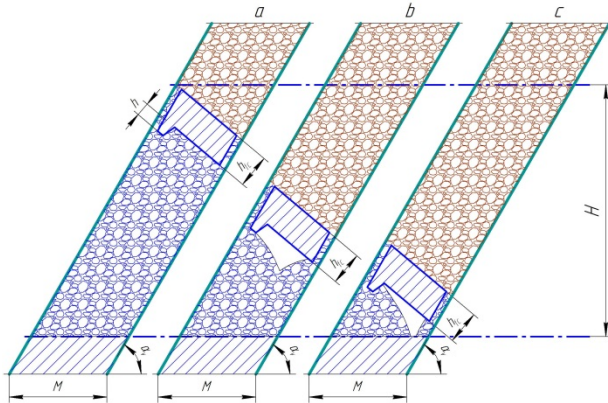

Fig. 9. The diagram of movement of the FC with a protective brow from the hanging wall side when drawing caved ore: a – the initial stage; b – the intermediate stage; c – the final stage.

Fig. 10 demonstrates that when forming a draw crater under the FC (the intermediate stage), the protective brow does not allow it to go beyond the protective structure that prevents waste rock from coming to the active drawing area.

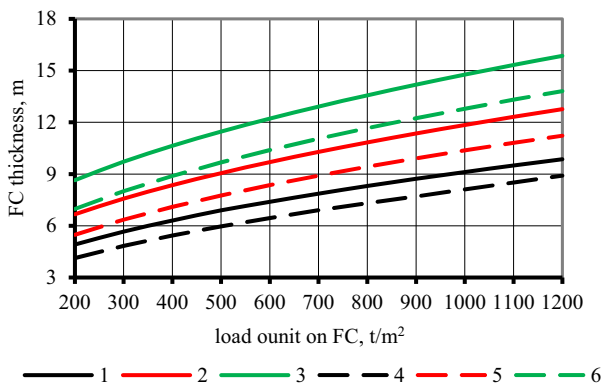

Fig. 10. Dependency of the “floating” crown with the protective brow on the unit load on the protective structure and its parameters at: 1, 2, 3 – the FC lengths of 40, 50 and 60 m respectively at the angle of 0°; 4, 5, 6 is the FC lengths of 40, 50 and 60 m respectively at the angle of 40° to the receiving level.

As is seen in Fig. 10, if the unit load on the FC increases from 3 200 to 1200 t/m² and the crown incline makes 0° and 40°, the crown thickness grows from 4.9 to 15.9 m to 4.1 to 13.8 m respectively. It should be noted that the character of crown thickness changes at the angles of 0° and 40° are similar. Thus, it can be concluded that calculations based on the enhanced methods provide reliable results.

Analysis of calculations in Fig.7 and 10 shows that it is possible to decrease the crown thickness applying the protecting brow in the upper part of the FC. It should be

noted that the crown thickness decrease leads to increase in general reserves in the FC at the expense of ore reserves in the protecting brow.

To reduce dilution of the caved ore and decrease rock pressure manifestations, we suggest a system with bulk caving of ore and overlying rocks applying the “floating” crown (Fig. 11).

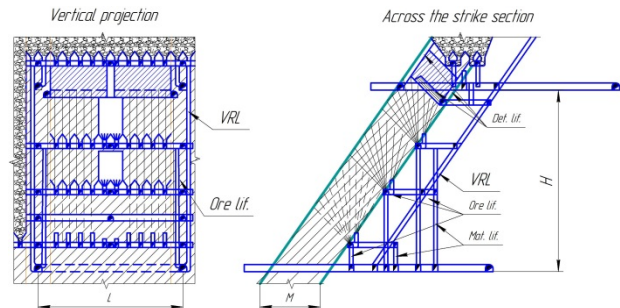

Fig. 11. The system of induced block caving with breaking ore on the vertical compensation room and applying the “I”-shaped “floating” crown.

The suggested mining system consists in the following. In the upper part of a stope a FC is formed by breaking ore massif along its contour. The stope is conditionally divided into two or three levels where a scraper entry is located from which ore massif is broken on the vertical compensation room.

Geometry of the mining system is as follows: the level height is 10 m, the block length is 60 m, thickness is 25 m, the FC thickness is 15 m according to the calculations (Fig.10). Preparation of the block starts with driving access ors from the haulage entry and driving ventilation and manway raises on the flanks of the mining block. Then the level is conditionally divided into 25 m long sublevels; from ventilation and manway raises, ventilation and manway ors are driven to which service and ore discharge raises are driven up from the haulage level. A scraper entry is driven from the ventilation and manway ors in the footwall. 5-7 m high drawpoints go out of the scraper entry [55-58].

A 15 m thick FC is formed in the upper part of the stope. The FC is cut by driving horizontal and vertical cutoffs. To prevent the active drawing zone from going beyond the FC, the “I”-shaped protective structure is suggested.

The ore massif of the main reserve is caved after creating the FC. For this, the ore massif is broken by blasthole rings. from the scraper entry on the previously created compensation room. After that, the blasthole rings are fired with delay.

Caved ore drawing begins at drawpoints located in the block center (according to Yu.P. Kaplenko) to create a single active drawing zone (according to S.V. Pysmennyi) until the fragmentation ellipsoid reaches the FC (this makes about 15-20% of the main block reserve). After the fragmentation ellipsoid reaches the FC in the ore massif, the fragmentation factor will be over 1.5. This will enable the FC to move vertically due to its own weight and the weight of the overlying rocks. After the FC movement, the fragmentation factor in the block will decrease to 1.3 and this will stop movement of the protective structure.

With further ore drawing, the factor changes to 1.5, this resulting in the FC movement.

As ore breaking is performed by stages, a pillar is left above workings of the receiving level. The pillar absorbs loads from the broken ore, the crown and caved rocks, thus limiting conditions of rock pressure manifestations in workings. After extracting 50% of ore mass, the lower part of the ore massif is drilled out and ore drawing continues [59-61].

General technical and economic data is given in Table 1.

Table 1. Technical and economic data by mining systems.

Parameters	Mining system	
	Traditional	Suggested
Balance ore reserve in block, t	420746	420746
Ore mass mined from block, t	401621	388577
Specific consumption for workings, m/kt	4,3	4,4
Per meter run:		
a) while forming compensation space, t	12.9	12.1
b) while bulk caving, t	18.4	18.4
c) with “floating” crown	–	15.2
Blasting ratio: kg/t		
a) packaged explosives	1.35	1.52
b) granular explosives	0.267	0.294
Labor efficiency, t/shift:		
a) at breaking	1052	898
b) at transportation	509	542
c) by mining system	52.1	50.9
Fe content, %:		
a) in massif	62.0	62.0
b) in ore mass mined	58.63	59.63
Ore loss, %	16.0	18.8
Ore dilution, %	14.0	9.85
Cost of 1t of ore	11.48	11.14

Table 1 demonstrates that application of the FC mining system results in mining costs reduced by 0.34 USD/t, ore losses increased by 2.8% (FC ore excluded), and ore dilution decreased by 4.15% as compared with traditional mining systems. Iron content in the mined ore increases by 1.0%.

Conclusions

The research conducted enables the following conclusions:

1. Based on the analysis of mining and geological conditions of mining under rock pressure in Kryvyi Rih iron ore basin, enhancement of ore extraction from the stope has been proved possible due to application of the protective structure.

2. The current methods of calculating the “floating” crown thickness enable determining its optimal parameters to ensure its integrity when stoping. However, there are no developed techniques of applying the FC when mining steep ore bodies.

3. The enhanced methods have been developed to determine the FC thickness considering the dip angle of the ore body. Based on the research conducted, there has

been developed a system of block caving with application of the “floating” crown to mine steep ore bodies that enables decrease of ore dilution, increase of Fe content in the mined ore without considerable growth of ore costs.

The work was supported by the Ministry of Education and Science of Ukraine within the framework of the state scientific topics “Determination of regularities of the stress-strain state of rocks disturbed by workings with the purpose of developing resource-saving ore mining technologies” (State registration No. 0115U003179).

References

1. M. Stupnik, O. Kalinichenko, V. Kalinichenko, S. Pysmennyi, O. Morhun, Choice and substantiation of stable crown shapes in deep-level iron ore mining. *MMD*. **12(4)**, 56–62 (2018). doi:10.15407/mining12.04.056.
2. M. Stupnik, V. Kalinichenko, Annual Scientific-Technical Colletion - Mining of Mineral Deposits 2013. 49–52 (2013)
3. O. Khomenko, A. Sudakov, Z. Malanchuk, Ye. Malanchuk, *Naukovi Visnyk Natsionalnoho Hirnychoho Universytetu*. **2**, 35–43 (2017)
4. M. Petlovanyi, V. Lozynskyi, S. Zubko, P. Saik, K. Sai, *Rudarsko Geolosko Naftni Zbornik*. **34(1)**, 83–91 (2019). doi:10.17794/rgn.2019.1.8
5. M. Stupnik, V. Kolosov, S. Pysmennyi, K. Kovbyk, Selective mining of complex structured ore deposits by open stope systems. *E3S Web of Conferences*. **123**, 01007 (2019). <https://doi.org/10.1051/e3sconf/201912301007>.
6. M. Stupnik, V. Kalinichenko, S. Pysmennyi, O. Kalinichenko, M. Fedko, Method of simulating rock mass stability in laboratory conditions using equivalent materials. *MMD*. **10(3)**, 46–51 (2016). doi:10.15407/mining10.03.046
7. M.I. Stupnik, V.O. Kalinichenko, O.V. Kalinichenko, I.O. Muzika, M.B. Fed’ko, S.V. Pismennyi, *Metallurgical and mining industry*. **7**, 377–383 (2015)
8. O. Khomenko, M. Kononenko, M. Petlyovanyy, *Progressive Technologies Of Coal, Coalbed Methane, And Ores Mining*. 241–245 (2014). doi:10.1201/b17547-43
9. M. Petlovanyi, V. Lozynskyi, P. Saik, K. Sai, Predicting the producing well stability in the place of its curving at the underground coal seams gasification. *E3S Web of Conferences*. **123**, 01019 (2019). doi:10.1051/e3sconf/201912301019
10. Z. Malanchuk, V. Moshynskyi, Y. Malanchuk, V. Korniienko, M. Koziar, *Key Engineering Materials*. **844**, 77-87 (2020). doi:10.4028/www.scientist.net/KEM.844.77
11. M.B. Fedko, V.A. Kolosov, S.V. Pismenny, Ye.A. Kalinichenko, *Naukovi Visnyk Natsionalnoho*

- Hirnychoho Universytetu. **4**, 79–84 (2014)
12. V. Kalinichenko, O. Dolgikh, L. Dolgikh, E3S Web of Conferences. **123**, 01047 (2019). doi:10.1051/e3sconf/201912301047
 13. N. Stupnik, V. Kalinichenko, Geomechanical Processes During Underground Mining - Proceedings of the School of Underground Mining, 15–17 (2012)
 14. O. Kalinichenko, M. Fedko, I. Kushnerov, M. Hryshchenko, Muck drawing by inclined two-dimensional flow. E3S Web of Conferences. **123**, 01015 (2019). doi:10.1051/e3sconf/201912301015
 15. N.I. Stupnik, V.A. Kalinichenko, M.B. Fedko, Ye.G. Mirchenko, Naukovyi Visnyk Natsionalnoho Hirnychoho Universytetu. **2**, 11–16 (2013)
 16. N.I. Stupnik, V.A. Kalinichenko, M.B. Fedko, Ye.G. Mirchenko, Naukovyi Visnyk Natsionalnoho Hirnychoho Universytetu. **1**, 44–48 (2013)
 17. V. Morkun, V. Tron, Metallurgical and Mining Industry. **5**, 8–10 (2014)
 18. V. Morkun, N. Morkun, A. Pikilnyak, Metallurgical and Mining Industry. **2**, 35–38 (2015)
 19. V. Golik, V. Morkun, N. Morkun, V. Tron, Acta Mechanica et Automatica. **13**(2), 113–123 (2019). doi:10.2478/ama-2019-0016
 20. V. Tron, O. Tsokurenko, D. Paraniuk, I. Haponenko, E3S Web of Conferences. **123**, 01037 (2019). doi:10.1051/e3sconf/201912301037
 21. V. Morkun, N. Morkun, V. Tron, Metallurgical and Mining Industry. **5**, 7–11 (2015)
 22. V. Morkun, V. Tron, Metallurgical and Mining Industry. **6**, 4–7 (2014).
 23. V. Morkun, S. Tcvirkun, Metallurgical and Mining Industry. **5**, 11–14 (2014)
 24. V. Morkun, V. Tron, S. Goncharov, Metallurgical and Mining Industry. **2**, 31–34 (2015)
 25. O. Krukovskiy, V. Krukovska, E3S Web of Conferences. **109**, 00043 (2014). doi:10.1051/e3sconf/201910900043
 26. V. Tron, A. Haponenko, I. Haponenko, D. Paranyuk, E3S Web of Conferences. **201**, 01025 (2020). doi:10.1051/e3sconf/202020101025
 27. V. Morkun, N. Morkun, A. Pikilnyak, Metallurgical and Mining Industry, **3**, 28–31 (2014)
 28. Ye. Malanchuk, V. Korniienko, L. Malanchuk, V. Zaiets, E3S Web of Conferences. **211**, 01036 (2020). doi:10.1051/e3sconf/202020101036
 29. O. Krukovskiy, V. Krukovska, Yu. Vynohradov, MMD. **11**(2), 21–27. (2017). doi:10.15407/mining11.02.021
 30. V. Tron, O. Tsokurenko, D. Paraniuk, I. Haponenko, E3S Web of Conferences. **123**, 01037 (2019). doi:10.1051/e3sconf/201912301037
 31. V. Lozynskiy, V. Medianyuk, P. Saik, K. Rysbekov, M. Demydov, Rudarsko Geolosko Naftni Zbornik. **35**(2), 23–32 (2020). doi:10.17794/rgn.2020.2.3
 32. R. Dychkovskiy, Ia. Shavarskiy, P. Saik, V. Lozynskiy, V. Falshtynskiy, E. Cabana, MMD. **14**(2), 85–94 (2020). doi:10.33271/mining14.02.085
 33. O. Bazaluk, M. Petlovanyi, V. Lozynskiy, S. Zubko, K. Sai, P. Saik, Sustainability, **13**(2), 834 (2021). doi:10.3390/su13020834
 34. O. Khomenko, M. Kononenko, M. Petlyovanyy, Progressive Technologies Of Coal, Coalbed Methane, And Ores Mining. 241–245 (2014). doi:10.1201/b17547-43
 35. M. Petlovanyi, O. Kuzmenko, V. Lozynskiy, V. Popovych, K. Sai, P. Saik, MMD. **13**(1), 24–38 (2019). doi:10.33271/mining13.01.024
 36. D.V. Brovko, V.V. Khvorost, V.Yu. Tyshchenko, Naukovyi Visnyk Natsionalnoho Hirnychoho Universytetu. **4**, 66–71 (2018). doi:10.29202/nvngu/2018-4/14
 37. O. Khomenko, M. Kononenko, M. Petlovanyi, New Developments In Mining Engineering 2015, 265–269 (2015). doi:10.1201/b19901-47
 38. G. Pivnyak, R. Dychkovskiy, E.C. Cabana, V. Lozynskiy, P. Saik, Key Engineering Materials, (844), 4. Trans Tech Publications Ltd., Switzerland. ISBN: 978-3-0357-1139-4 (2020). doi:10.4028/www.scientific.net/KEM.844
 39. S. Dineva, M. Boskovic, in J Wesseloo (ed.), Proceedings of the Eighth International Conference on Deep and High Stress Mining. Australian Centre for Geomechanics. 125–139 (2017)
 40. Y. Biruk, H. Mwagalanyi, Master's thesis. Department of Civil, Environmental and Natural Resources Engineering. **74** (2010)
 41. H.A. Aytashev, V.A. Isakov, H.A. Prokushev, KH.YU. Tsunzava, H.YE. Chernyshov, Hirnychyy zhurnal. **11**, 31–37 (1968)
 42. K. Rysbekov, D. Huayang, T. Kalybekov, M. Sandybekov, K. Idrissov, Y. Zhakypbek, G. Bakhmagambetova, Mining of Mineral Deposits. **13**(3), 40–48 (2019). doi:10.33271/mining13.03.040
 43. T. Kalybekov, M. Sandibekov, K. Rysbekov, Y. Zhakypbek, Substantiation of ways to reclaim the space of the previously mined-out quarries for the recreational purposes. E3S Web of Conferences. **123**, 01004 (2019). doi:10.1051/e3sconf/201912301004
 44. YU.P. Kaplenko, V.A. Kolosov, Mineral. **177** (2001)
 45. A.D. Chernykh, I.A. Kalishevskiy, A.M. Mayevskiy, D.V. Gordin, Sích. **318** (1993)
 46. D. Anastasov, N.Valkanov, L. Totev, G. Dachev, I.Mitev, 25th World Mining Congress. 1328-1336 (2018)
 47. V. Korniyenko, V. Nadutyi, Y. Malanchuk, M. Yeluzakh, MMD. **14**(4), 90-96 (2020). doi:10.33271/mining14.04.090
 48. D. Anastasov, At. Marinski, 22nd World Mining Congress. **1**, 177-179 (2011)
 49. Z. Malanchuk, V. Moshynskiy, P. Martyniuk, S. Stets, D. Galiyev, E3S Web of Conferences. **211**, 01011 (2020). doi:10.1051/e3sconf/202020101011

50. A.S. Vol'mir, *Tekhniko-teoreti-cheskaya literature*. 419 (1956).
51. V. Moshynskiy, Z. Malanchuk, V. Tsymbaliuk, L. Malanchuk, R. Zhomyruk, O Vasylchuk, *MMD*, **14**(2), 95-102 (2020). doi:10.33271/mining14.02.095
52. V. Tron, A. Haponenko, I. Haponenko, D. Paranyuk, *E3S Web of Conferences*. **201**, 01025 (2020). doi:10.1051/e3sconf/202020101025
53. Z. Malanchuk, V. Korniyenko, Ye. Malanchuk, A. Khrystyuk, M. Kozyar, *E3S Web of Conferences*. Volume **166**, 02008 (2020). doi:10.1051/e3sconf/202016602008
54. V. Lozynskiy, P. Saik, M. Petlovanyi, K. Sai, Ye. Malanchuk, *International Journal of Engineering Research in Africa*. **35**, 77-88 (2018). doi:10.4028/www.scientific.net/JERA.35.77
55. V. Falshtynskiy, V. Lozynskiy, P. Saik, R. Dychkovskiy, M. Tabachenko, *MMD*, **10**(1), 16-24 (2016). doi:10.15407/mining10.01.016
56. R.O. Dychkovskiy, V.H. Lozynskiy, P.B. Saik, M.V. Petlovanyi, Ye.Z. Malanchuk, Z.R. Malanchuk, *Archives of Civil and Mechanical Engineering*, **18**(4), 1183-1197 (2018). doi:10.1016/j.acme.2018.01.012
57. O. Dolgikh, L. Dolgikh, *E3S Web of Conferences* **166**, 03002 (2020). doi:10.1051/e3sconf/202016603002
58. V. Tron, A. Haponenko, I. Haponenko, D. Paranyuk, *E3S Web of Conferences*. **201**, 01025 (2020). doi:10.1051/e3sconf/202020101025
59. S. Pysmennyi, M. Fedko, N. Shvaher, S. Chukharev, *E3S Web of Conferences*. **201**, 01022 (2020). doi:10.1051/e3sconf/202020101022.
60. O. Dolgikh, L. Dolgikh, I. Kuchnerov, *E3S Web of Conferences* **201**, 01029 (2020). doi:10.1051/e3sconf/202020101029
61. Z.R. Malanchuk, V.S. Moshynskiy, V.Y. Korniienko, Y.Z. Malanchuk, V.H. Lozynskiy, *Naukovyi Visnyk Natsionalnoho Hirnychoho Universytetu*, **6**, 11-18. (2019). doi:10.29202/nvngu/2019-6/2