

Optimizing modified triaxial testing for small strain zone using local displacement transducers and bender element for cement-treated soft soil

Muhammad Akmal Putera^{1*}, Noriyuki Yasufuku¹, Adel Alowaisy¹, and Ahmad Rifai²

¹Kyushu University, Department of Civil and Structural Engineering, 744 Motoooka, Nishi-Ku, Fukuoka, Japan

²Gadjah Mada University, Department of Civil and Environmental Engineering, 55281 Yogyakarta, Indonesia

Abstract. The settlement behavior is a common problem on the railway structure that can be optimized by applying cement-treated soil as ground restoration. However, the application of a high cement mixing content needs a proper estimation that can be achieved by adjusting the element testing. The strain measurement devices can estimate the deformation characteristics, such as secant modulus, Poisson ratio, and shear modulus that can describe the settlement behavior and stiffness of cement-treated soil. This research is focused on a static analysis of triaxial consolidated undrained (\overline{CU}) testing that is improved by the axial and radial local displacement transducer (LDT) and bender element to increase the accuracy of measurement results. Furthermore, the secant modulus and shear modulus is more accurate when the combination of radial and axial LDT is used due to a small strain range. Lastly, the shear modulus measurement is improved by using a filler in the cement-treated soil for the bender element test. To conclude, this system of testing for the static condition can be utilized for the dynamic condition, because the measurement shows a reliable result for a small strain range which is the parameter of the dynamics condition.

1 Introduction

Recently, the railway structures industry has reported various technical problems related to deflection on ballastless structures. Ballastless structures consist of the slab track and cement composite with 50 cm thickness on average. The railway deflection problem is directly related to the underlying soil, where the excessive and long-lasting settlement in soft soil ground may induce significant damage and cracking to the structure. Therefore, proper control and evaluation of the soft soil settlement beneath railway structures is strongly needed, wherein standard, it should not exceed 2 mm/year.

Several techniques were developed to overcome the settlement of natural ground and can be generally divided into mechanical and chemical reinforcement. Under the chemical reinforcement group, cement treatment is widely adopted especially in developing countries due to its effectiveness and relatively low cost. Deformation characteristics associated with settlement behavior need to observe in soft soil and cement-treated soil is shear modulus, Young's modulus, and Poisson ratio.

To understand and provide effective solutions for the settlement problem, accurate determination of the soft soil's mechanical parameters is a key factor. Generally, those parameters are determined using laboratory element testing, where the Triaxial Consolidated Undrained (\overline{CU}) is commonly used when dealing with soft ground and cement-treated soils [1] [2]. The advantage of measuring

the settlement parameter with Triaxial \overline{CU} testing is the ability to determine the parameter only large strain (1 – 15%). However, using the conventional testing method includes difficulties associated with determining the soil behavior in a small strain zone (10^{-6} – 1%). For this reason, applying the local and external strain measurement devices can be used to determine strain range behavior along with the shear modulus.

Several studies have been carried out to investigate the local measurement using Local Displacement Transducer (LDT) and Bender Element (BE) in Triaxial [3] [4]. These studies focused primarily on the reliability of the LDT to measure the deformation characteristics of soil when subjected to monotonic and cyclic loadings. In addition, radial deformation determination is also crucial. Also, inevitable discrepancies in the axial strain orientation determined based on the local and external measurement in the strain range smaller than 1% that is used to determine the shear modulus especially when dealing with cement-treated soils were reported. In addition, the measurement is also affected by the shearing rate, where 0.005% is conventionally used, and the bedding phenomenon during the sample preparation. Bedding error has difficulties related to BE test which was the incorrect measurement from a large cavity on specimen [5] [6]. Consequently, to ensure the reliable determination of the deformation properties, the sample preparation, testing methodology, and measurement need to be optimized.

* Corresponding author: muhammad.akmal.putera@gmail.com

This study aims at optimizing the Triaxial \overline{CU} testing system when combined with local and external strain measurement devices and BE system. Also, the accuracy of the adopted determination methodology of the deformation characteristic in cement-treated soil is discussed.

2 Experimental setup and methodology

In laboratory analyses focused on Triaxial \overline{CU} to determine the deformation characteristic associated with the testing procedure. The testing procedure of the conventional method has been utilized for measuring the small strain ranges using LDTs and BE devices [7] [8]. Therefore, sample preparation has been explained by the optimization of cement-treated soil to ensure reliable measurement in a small strain range.

2.1 The testing procedure of Triaxial \overline{CU}

This research was using Triaxial \overline{CU} in static condition test as shown in Fig. 1. The standard of testing in the conventional method on shear loading rate is about 0.005 mm/min, referred to as a clay material in JGS 0821. In the conventional method, there are critical measurement devices such as linear variable displacement transducers (LVDT) to measure the deformation characteristic from the outside triaxial chamber.

The coefficient of LVDT is about 0.005508 in 1 mm. Also, a pressure meter to determine volume change during the consolidation process. The coefficient of the pressure meter is about 0.0106 in $1 \mu\epsilon$. However, the limitation of using conventional tests cannot define the radial displacement during the shearing process. Also, the consequences for using the LVDT outside the chamber are the bedding error on the top and bottom on cement-treated soil. For this reason, the utilization of local strain measurement is needed.

The accuracy of strain measurement using LVDT is about 0.01 mm, this resolution is associated with strain range measurement. For instance, the measurement with LVDT has coverage of the strain range within 0.01 to 10% explained by Fig. 2. However, this strain range measurement needs to evaluate with the local strain measurement devices. Furthermore, the accuracies on deformation characteristics properties such as shear modulus (G) and secant modulus (E_{sec}) need to define by comparing the LDT and LVDT results.

2.1.1 Axial and Radial LDT

LDT specification made by bronze plate and the dimension is about 90 mm on length, 3.5 on width, and 0.2 on thickness. The dimension can be seen in Fig. 3. The LDT must be calibrated to keep the strain in every testing. The pseudo-hinged specification is made by a bronze plate with a specified angle to attach the axial LDT as illustrated by Fig. 4a. Therefore, the attachment method using the pseudo-hinged into membrane needs to reinforce with epoxy glue to ensure the detached problem during measurement, as described in Fig. 4b.

The coefficient of LDT can be defined by using the calibration of the deformation test. The calibration of axial LDT is used to describe the non-linear relationship of the output voltage with the displacement is shown in Fig. 5a. It describes that the limitation of the displacement is about 5 mm and 5% in the strain range. On the other hand, the radial LDT is used to describe the linear relationship. It can be seen in Fig. 5b. The Figure shows that the negative and the positive limitation is about 1.5 mm and 1.5 mm. From this result, the initial condition has been evaluated and the test condition saved in every axial and radial LDT testing.

The accuracy of strain measurement using LDT is about 0.0001 mm. This resolution is associated with the strain range measurement. The potential for using the LDT to measure the strain range between 1 to 0.0001% can be carried out from the initial test. The resolution is based on the calibration and limitation of the LDT initial measurement. However, the result of the calculation in LDT is used to evaluate the deformation characteristics properties during the shearing process.

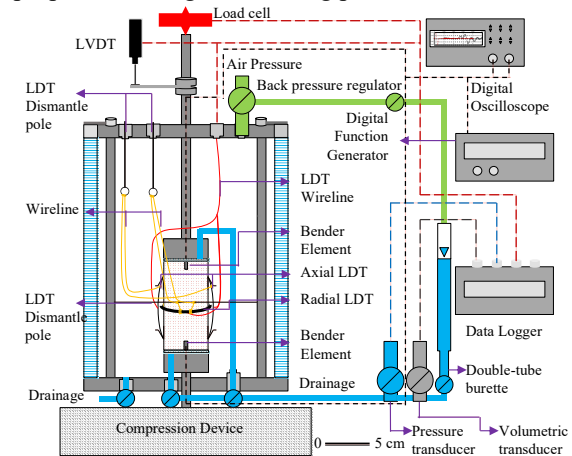

Fig. 1. Triaxial \overline{CU} setup

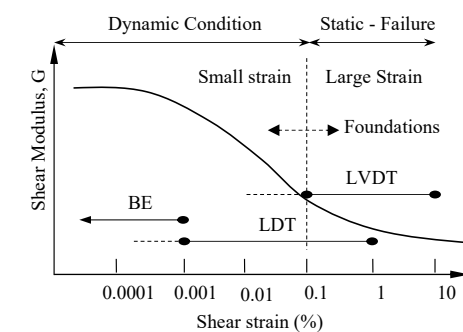

Fig. 2. Typical stiffness variation and variances of strain levels for laboratory tests and structures.

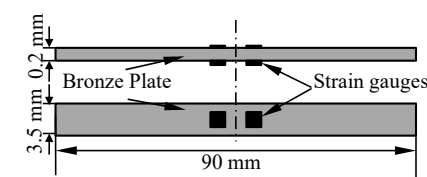

Fig. 3. LDT geometry specification

During the shearing process, the change of stress strain from the LDT and the load cell needs to be recognized. For instance, before the LDTs reach the limitation of displacement it needs to detach immediately from pseudo-hinged. Occasionally, the radial LDT was unable to be dismantled due to the pressure inside the triaxial chamber that pushed the LDT through the specimen. The dismantled problem in radial LDT has been solved by using dismantle pole with a wire connected to the axial and the radial LDT. Therefore, the system procedure of dismantled LDTs from pseudo-hinged has been explained with dismantling pole to maintain the LDTs lifespan.

2.1.2 BE devices

The material of BE is consists of silver, piezoelectric ceramic, and nickel as an electrode. The original dimension of BE that was used in the test is about 10-20 mm in length, 10 mm in width, and 1.5-2.5 mm in thickness. The dimension has been widened by coating the BE with epoxy glue to protect it from water. The dimension information in the test is the same as the curing mold shown in Fig. 6.

The shear modulus is obtained by analyzing the arrival time and amplitude in receiving the data from the oscilloscope. There are several methods to determine shear modulus, such as the start-to-start method, peak-to-peak method, and cross-correlation method. This research was used the peak-to-peak method to evaluate the shear modulus. The data from laboratories that used a single pulse of sine wave input. Shear wave velocity was observed from the peak position of an input wave to the first peak of the received wave.

There are different responses at shear modulus is from the effectiveness in sample preparation with filler and without filler. The filler needs to use from bedding errors on the top and bottom surface. The filler is consists of bentonite and gypsum mixture. Filler composition method that was used in test by ratio 1:2 of binder to water. The texture and structure can be explained by Fig. 7.

The result to analyze the reliable curve can be shown from Fig. 8a is used to determine the reliable results by using the bender element in the triaxial apparatus. Fig. 8b is used to identify the less reliable result due to bedding error and indicate the sample preparation in cement-treated soil. Furthermore, reliable results are used to obtain filler applications on both sides of the test object, then describe the effective results with filler on the test object. In the meantime, the filler proportion could be advantageous for some reason, and the future analysis should be enhancing the effectiveness of the filler types in several experimental conditions.

2.2 Sample Preparation

The specimen needs to be prepared with an appropriate condition to understand the reliable result condition to examine the system of testing with the triaxial $\bar{C}\bar{U}$ test. The material used for this study is the Ariake clay from Saga Prefecture. Then the properties are shown in Table 1. The explanation of the preparation method for the specimen to mix soil cement from marine clay is depicted in Fig. 9. The steps of sample preparation and the installation procedure for the cement-treated soil-applied in the bender element test are as follow:

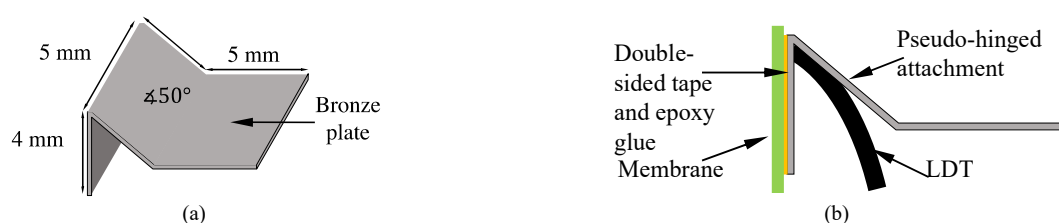

Fig. 4. (a) pseudo-hinged geometry specification and (b) pseudo-hinged technique attachment

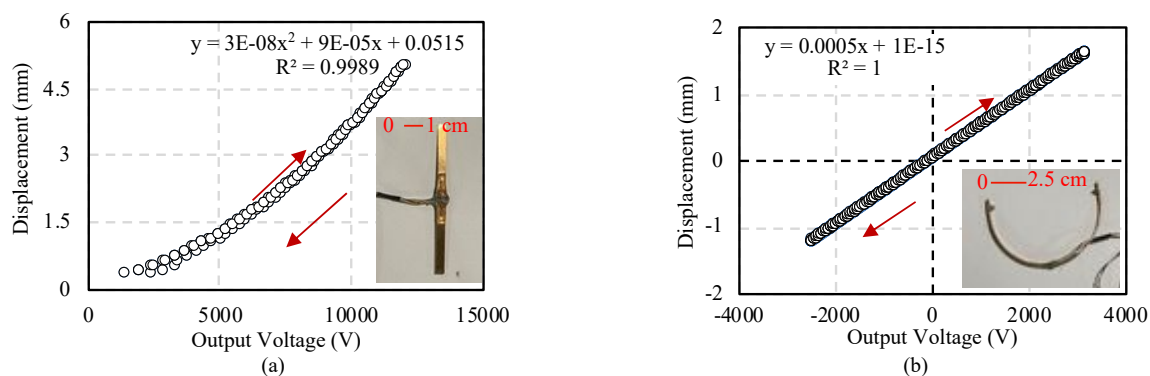

Fig. 5. (a) Calibration result of the Axial LDT and (b) radial LDT

Table 1. Soil properties

Soils	Natural Water Content (%)	Specific Gravity	425 μm size (%)	D_{50} (mm)	Liquid Limit (%)
Ariake Clay	240	2.547	100	8.59×10^{-4}	128.5

2.2.1 The mixing phase

The mixing process of cement with soil has been widely used by several researchers. Ariake Clay is characterized by a high water content which is about 240%. Due to the high water content, it can indicate that the use of mixing criteria is based on the liquidity index [2]. If the value of the liquidity index is twice the dry mass, the most suitable mixing method is the dry mixing method. Hence, no more water is needed. It is worth noting that the percentage of the cement addition is based on the ratio of the dry mass and the cement weight.

2.2.2 Pre-curing phase

In this phase, cement-mixed soil has been developed in a slurry condition. This condition is prepared by the modified mold and set up the slurry condition to the modified curing mold. The modified mold has been made using acrylic and a steel plate to create a casting hole which is used to penetrate the bender element. During the curing period, the modified curing mold has the advantage to create a proper casting for bender element plates from both directions (upper side and bottom side) to anticipate the cracking damage. Furthermore, to prevent any cracking damages at the post-curing phase, we need to rub the mold with grease in advance. These methods have been applied for mixing the specimen inside the curing mold by tamping the mold from the bottom side. The tamping process is carried out about 30 times for each layer. However, it is better to keep the slurry condition of the cement-treated soil before pouring the cement-mixed soil into the modified mold.

2.2.3 Post-curing phase

The next step is the post-curing phase. Inside the modified curing mold, there is a progressive reaction such as the hardened reaction inside the mold, and by the time the cement-treated soil structure then becomes concrete. The removal of the specimen from the curing mold is a common problem during this process. There was cracking damage from the specimen that can be caused by the looseness of the tape or the airtight seal that is attached to the specimen.

2.2.4 Specimen setup

The remaining phase is to set up the specimen into the bender element test. As the previous research encountered a problem and difficulties during handling a special procedure of the conventional testing method, so a slight modification is required. Conventional testing methods can be carried out in two conditions, static and dynamic conditions. Both have difficulty determining the incremental stress behavior with bedding error from

surfaces related to the upper and bottom sides. For this reason, using the filler to cover the bedding surface can improve the shear modulus measurement. Furthermore, we need to carefully consider the sample preparation and installation procedures to evaluate the accuracy of the resulting deformation characteristics of the specimen, which in this study is a cement-treated soil with high cement content.

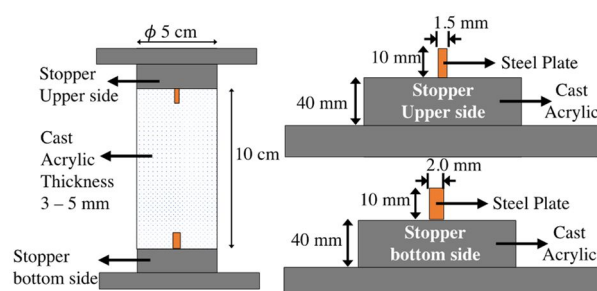

Fig. 6. Curing mold specification with bender element shape

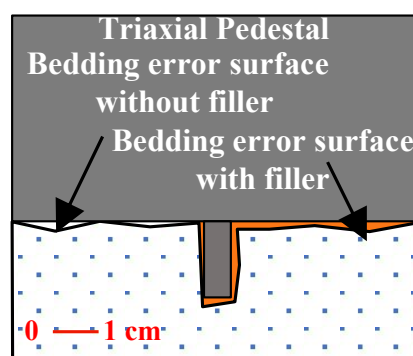

Fig. 7. The texture of structure of bedding surface with filler and without filler

3 Local and External strain measurement devices

3.1 Stress-strain relationship

The combination amongst the LDT and LVDT devices in Triaxial \bar{CU} can evaluate the axial (ϵ_a) and radial (ϵ_r) strain parameters during the shearing process. The relationship between the strain and deviatoric stress ($\sigma_a - \sigma_r$) is described by a nonlinear curve as illustrated by Fig. 10a and b. During 7 days of the curing period, the result shows a small difference in the peak of deviatoric stress by using LDT and LVDT. These deformation characteristics can be seen in Fig. 10a. However, on day 28 of the curing process, the result shows a peak difference of about 2% in the axial strain. The differences in the deviatoric stress and axial strain are associated with the radial strain, which describes the peak of radial strain in the axial LDT as bigger than LVDT measurement. However, the results are related to the bedding error

which increases as the stiffness of the specimen is increases. To improve the accuracy of stress-strain

relationship using cement-treated soil needed to use the strain measurement such as axial and radial LDT.

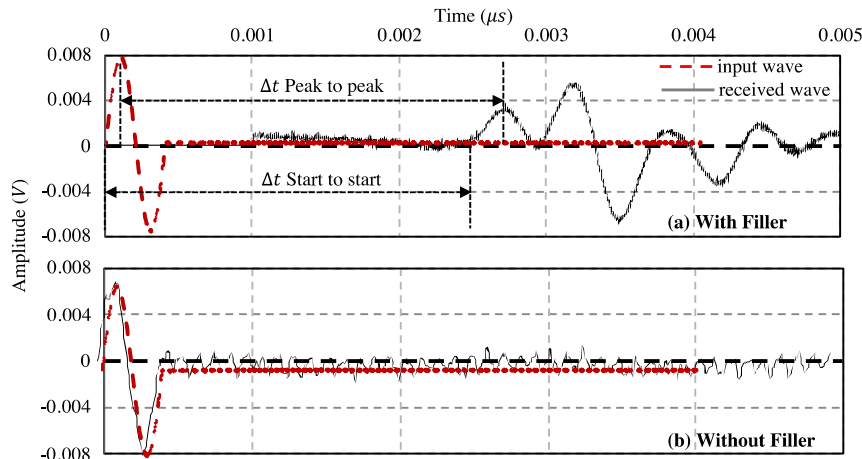

Fig. 8. Identification method using BE test (a) describe peak to peak and start to start method with filler and (b) describe the condition without filler

3.2 Poisson ratio

The deformation characteristics in the dynamic conditions such as Poisson ratio (ν) can be determined with the LDT by using the radial strain. The Poisson ratio can be defined by dividing the radial and axial strain.

$$\text{Poisson ratio} = -\frac{\text{change in radial strain}}{\text{change in axial strain}} = \frac{\Delta \varepsilon_r}{\Delta \varepsilon_a}$$

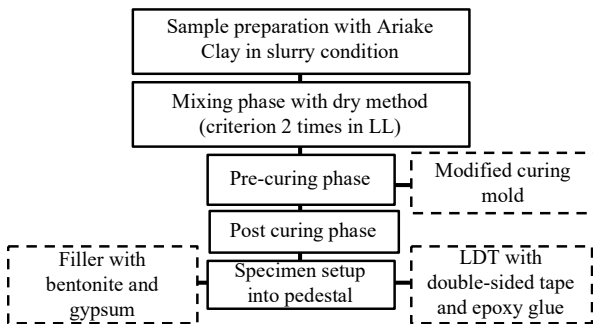

Fig. 9. Schematic diagram of the sample preparation procedure

The Poisson ratio can be determined during the shearing process associated with radiale strain and axial strain. The nonlinear occurred of the small strain range from 0.001 to 0.1%, which decreases of the Poisson ratio is observed by increasing the axial strain. The Poisson ratio from 28 days of curing is higher than the 7 days of curing as illustrated by Fig. 11a and b. The significant discrepancy is due to the axial strain and radial strain measurement of the 28 days of curing, which describes the stiffness higher than 7 days of curing. Fig. 11b shows the different result of the LVDT and LDT, where determine the significant discrepancy result start from 0.01% of the axial strain range with 28 days of curing. This can be interpreted as the differences of resolution between strain devices measurement and stiffness of specimen. The accuracy of

system testing to measure the Poisson ratio in small strain is ranged from 0.001% to 1% by using radial LDT. Based on the result of this analysis, further testing using more varied samples is considered to be essential to enrich the strain level behavior in the radial LDT.

4 Accuracy of Secant Modulus and Shear Modulus

4.1 Secant modulus

The measurement of the stiffness modulus utilizing the conventional triaxial \overline{CU} testing has been widely used for conventional testing to determine the strain range behavior. To understand the variety of the small strain range with stiffness modulus, the secant modulus must be determined. Furthermore, combining the LDT with conventional triaxial testing allows the determination of small strain ranges. The secant modulus can be defined by the stress-strain curve from zero value to 50% of the ultimate strength [9]. The advantage of using 50% of the ultimate strength level is that it can be applied in axial LDT, where the utilization of axial LDT has been recognized by measuring the variety of the small strain range.

$$\text{Secant Modulus} = E = \frac{\text{change in axial stress}}{\text{change in axial strain}} = \frac{\Delta \sigma_a}{\Delta \varepsilon_a}$$

The accuracy of the LDT testing in determining the secant modulus has been described in Fig. 12. The figure delineates the relationship between the axial strain and the secant modulus determined using conventional testing and the LDT. The results indicate that the soil stiffness decreases with the incremental increase of the axial strain. Fig. 12 (a) and (b) show the nonlinear relationship below the 1% axial strain, which describes the secant modulus for 7 days and 14 days of curing, respectively. Based on the results, it was found that the sample cured at 28 days has higher strength than the one cured at 7 days. Below the 1% axial strain for both samples in Fig. 12, the LDT

and LVDT curves showed some differences. However, the accuracy of testing using the LDTs has been observed well in small strain range from 0.001% to 1%.

4.2 Shear Modulus

The development of the system of testing for determining the shear modulus has been widely used for the deformation characteristics in experimental testing. To describe the shear modulus effect, the starting point from the beginning of testing to determine the nonlinearity of small strain level below 0.001%. The system of testing must be considered before applying the stress from consolidation pressure and the shearing process. The result of measuring the shear modulus in a small strain range is used to determine a system of testing in the static condition with conventional testing and applied the same initial strength condition on a system of testing to the dynamic condition. The Shear modulus can be defined by the following equation.

$$\text{Shear Modulus} = -\frac{(E)}{2(1 + \nu)}$$

The shear modulus can be determined during the shearing process based on the Poisson ratio and the secant modulus. The result of shear modulus was analyzed associated with strain measurements such as the axial strain in LDT and LVDT, as shown in Fig. 13. In 7 days of curing the small strain range below 0.1% is relatively linear, the condition can be seen in Fig. 13(a). On the other hand, the 28 days of curing has described the nonlinear condition. Therefore, it can be concluded that by increasing the axial strain, the shear modulus decreases.

The observation is made to evaluate the system of testing between LVDT and LDT from 0.01% to 1% in strain range as shown in Fig. 14. The result shows the shear modulus, which describes that the LVDT is underestimated from the axial LDT. Also, the capacity of LVDT cannot measure the value below 0.01%. The interpretation of initial shear modulus (G_{max}) has been described in 0.001%, which is the condition based on measurement of LDT and BE before shearing process and consolidation process. Meanwhile, the BE test can measure the G_{max} that shows the linear condition similar with LDT in small strain 0.001% to 0.01%.

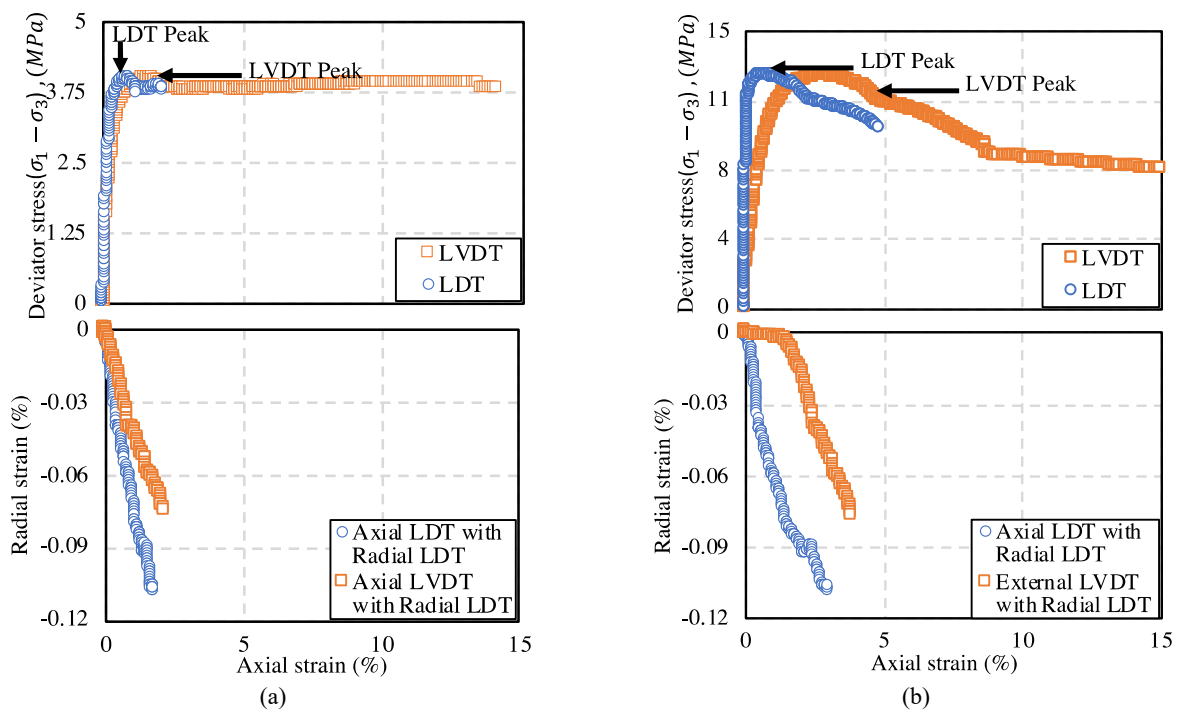

Fig. 10. Result of static loading test (a) 100 kPa of confining pressure with 50% cement content at 7D curing and (b) 100 kPa of confining pressure with 50% cement content at 28D curing

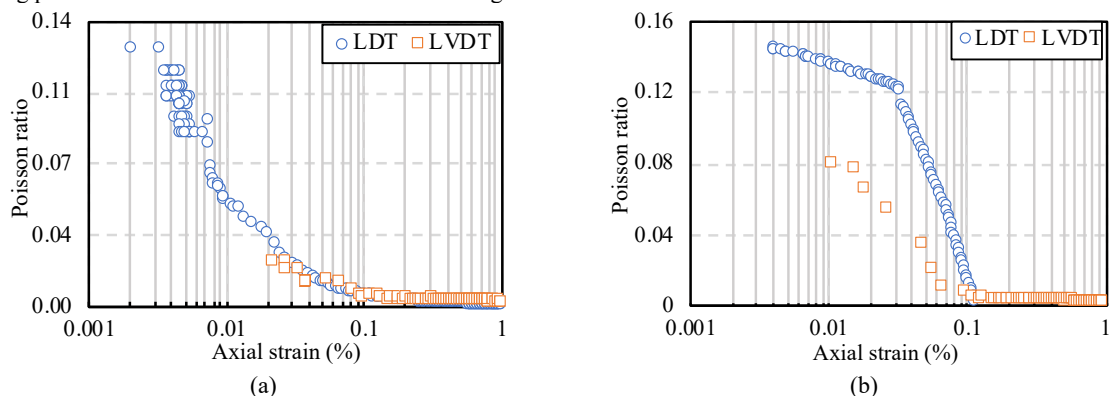

Fig. 11. Poisson ratio determination (a) 100 kPa of confining pressure with 50% cement content at 7D curing and (b) 100 kPa of confining pressure with 50% cement content at 28D curing

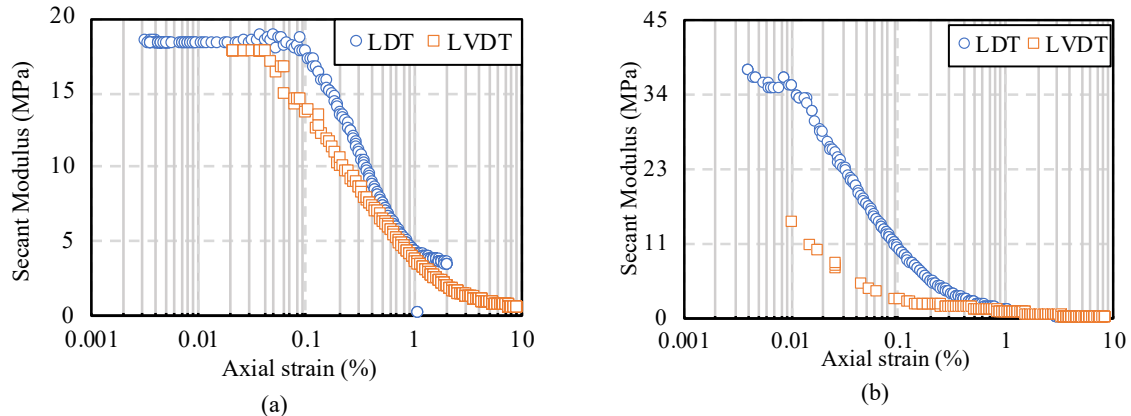

Fig. 12. Result secant modulus determination (a) 100 kPa of confining pressure with 50% cement content at 7D curing and (b) 100 kPa of confining pressure with 50% cement content at 28D curing

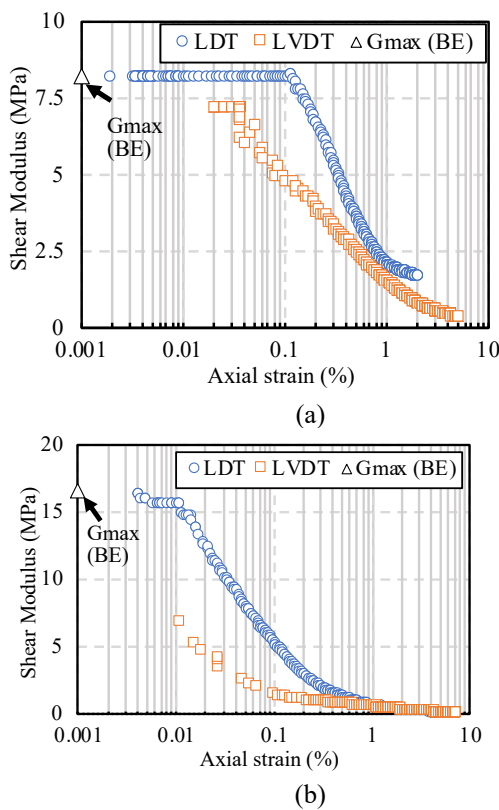

Fig. 13. The Shear Modulus result (a) 100 kPa of confining pressure with 50% cement content at 7D curing and (b) 100 kPa of confining pressure with 50% cement content at 28D curing

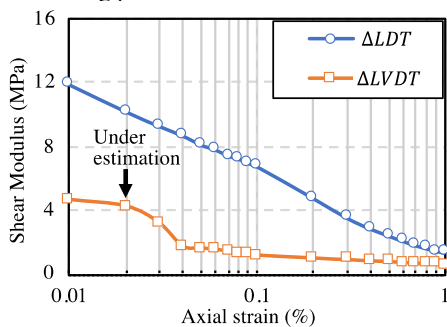

Fig. 14. Accuracy in shear modulus with axial strain using LDT and LVDT

5 Conclusion

Through this study, the CU bar testing system combined with local and external strain measurement devices and BE system was optimized for testing cement-treated soft soils focusing mainly on the small strain range. The main conclusions are delineated as follows:

1. To ensure reliable accurate measurement of the small strain using the axial and radial LDTs, it is recommended to fix the LDT's hinge to the outer surface of the membrane using epoxy glue and a double-sided tape to prevent the detachment of the hinge during shearing. On the other hand, it is necessary to use a filler paste to fill the cavity in the sample when installing the Bender Element to ensure reliable accurate measurement of the shear wave velocity.
2. A significant discrepancy of about 2% in the axial strain was measured using the LDT and the conventional LVDT. It was found that the difference became more significant after 28 days of curing, which can be related to the hardening of the cement-treated sample with time as confirmed from the BE results.
3. It was found that the shear modulus determined using the LDTs and the BE are in good agreement in the small strain zone (0.001 %), and differ significantly from the modulus determined using the LVDTs. The difference in the measured shear modulus determined using the LDTs and the LVDTs decreases towards larger strain ranges and converges to the same value for an axial strain equals or larger than 1%.
4. Finally, it can be concluded that to ensure the reliable determination of cement treated soft soils mechanical properties over the entire strain range, both LDTs for the small strain range (0.001 to 0.1) and LVDTs for the large strain range (> 1%) should be simultaneously used.

References

- 1 H. Atkinson, "Non-linear soil stiffness in routine design," *Geotechnique*, **50**, 5, 487-508 (2000)
- 2 K. Kasama, K. Zen, and K. Iwataki, "Undrained shear strength of cement-treated soils," *Soils and Foundations*, **46**, 2, 221-232 (2006)
- 3 S. Goto, F. Tatsuoka and S. Shibuya, "A simple gauge for local small strain measurements in the laboratory," *Soils and Foundations*, 31, 1, 169-180 (1991)
- 4 S. Yamashita, T. Kawaguchi, Y. Nakata, T. Mikami, T. Fujiwara, and S. Shibuya, "Interpretation of international parallel test on the measurement of G_{max} using bender elements," *Soils and Foundations*, 48, 4, 631-650 (2009)
- 5 K. Yao, Q. Chen., H. Xiao, Y. Liu, and F. H. Lee, "Small-strain shear modulus of cement-treated marine clay," *J. Mater. Civ. Eng.*, 32, 6 (2020)
- 7 H. Xiao, K. Yao, Y. Liu, S. Goh, and F. Lee, "Bender element measurement of small strain shear modulus of cement-treated marine clay – effect of test setup and methodology," *Construction and building materials*, 172, 433-447 (2018)
- 8 D. Xu, L. Borana, and J. Yin, "Measurement of small strain behavior of a local soil by fiber Bragg grating-based local displacement transducers," *Acta Geotechnica*, 9, 935–943, (2013)
- 9 S. S. Kumar, A. M. Krishna, and A. Dey, "Local strain measurement in a triaxial test using an on-sample transducer," in *Indian Geotechnical Conference, Chennai* (2016)
- 10 P. Malkowski, L. Ostrowski and J. Brodny, "Analysis of young's modulus for carboniferous sedimentary rocks and its relationship with uniaxial compressive strength using different methods of modulus determination," *Journal of Sustainable Mining*, 17, 146-157 (2018)