

# Designing blood supply policy using simulation approach

Eri Wirdianto<sup>1\*</sup>, Putri Ramadhani<sup>1</sup>, and Milana<sup>2</sup>

<sup>1</sup>Industrial Engineering Department, Faculty of Engineering, Andalas University, Indonesia

<sup>2</sup>Automotive Engineering Department, Faculty of Engineering, Padang State University, Indonesia

**Abstract.** Blood transfusion is one of the critical requirements of many medical treatments. To ensure timely blood availability, the Indonesian Red Cross (Palang Merah Indonesia/PMI) has to tackle the blood supply challenges of stockouts and overdates. This research aims to develop a simulation model to determine the blood supply policy to reduce stockouts and overdates. The simulation model was developed according to the existing system at UDD PMI Padang. Simulation experiments were then attempted with some sequential scenarios and carried out on variables that affect the blood supply. The simulation result recommends the blood supply policy to reduce blood stockout and overdate at a higher service level, at conditions of the blood demand is assumed to be constant or increased.

## 1 Introduction

Blood is needed in the human body in certain portions to function correctly. However, there are times when a person experiences a lack of blood that requires blood donation from others. For example, the need for blood can be caused by traffic accidents, natural disasters, surgeries, or other conditions. In this situation, blood donation is needed to replenish the amount of blood in the body.

The hospitals in Indonesia usually get blood supply from the nearest branch of the Indonesian Red Cross (Palang Merah Indonesia/PMI). In the City of Padang, the hospitals collaborate with a particular unit of PMI to manage blood supply called Blood Supply Unit (Unit Donor Darah/UDD). In the rest of this article, this unit is called PMI UDD Padang. PMI UDD Padang works to supply blood by collecting blood from the volunteers in the communities.

PMI UDD Padang obtains blood through volunteers who donate their blood. The blood supply system mechanism includes blood collection and qualification, blood processing, blood storage, and blood distribution. The blood obtained will go through an initial examination, doctor examination, followed by taking blood samples for quality and serological test, respectively. Damaged blood (containing disease) will be destroyed, while good blood is processed and separated into several blood components and stored in the blood bank as a stock.

The blood is commonly classified into some blood groups: A, B, AB, and O. Each blood group has to be stocked at certain levels to meet the blood demand of different blood groups [1]. Each of these blood groups can be synthesized into several blood components, which are Whole Blood (WB), Pack Red Cell (PRC), Fresh Frozen Plasma (FFP), Trombosit Concentrate (TC), and Cry-Precipitate/Anti-Haemophilic Factor (C-P/AHF). The

blood managed by PMI UDD Padang was presented in Fig. 1.

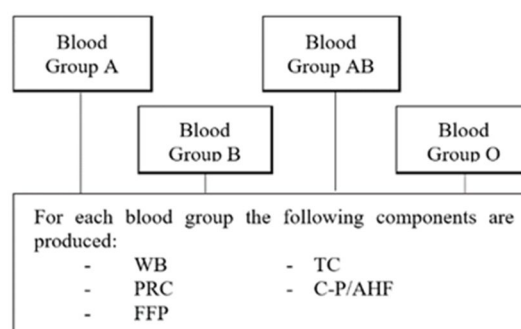
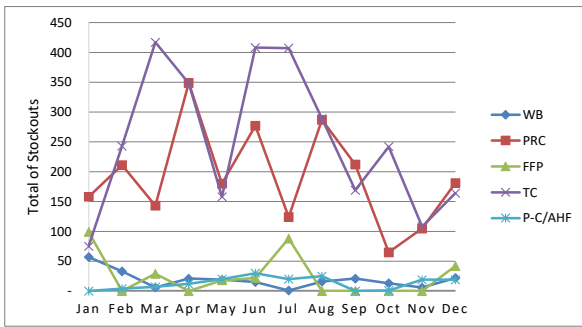

**Fig. 1.** Blood groups and types of blood components.

Based on a preliminary survey conducted at PMI UDD Padang, it is known that there was a condition where PMI UDD Padang was unable to meet the demand for some blood components due to stockouts. In contrast, some other blood components had excess stock and passed their expiration date. This circumstance is caused by inaccuracy estimation of the amount of blood needed at different components. The amount of blood supply shortage of PMI UDD Padang at a particular year can be seen in Fig. 2, while the amount of blood that has expired during that year can be seen in Fig. 3. Fig. 2 shows that the blood shortage for some blood components is very high, dominated by the lack of TC, followed by PRC. It indicates a significant difference between the availability of blood at PMI UDD Padang and the blood demand in specific blood components. Fig. 3 represents that the overdate blood for all blood products is still high. It happens because there is an excess stock of specific blood components, which causes such blood components to be

\* Corresponding author: [eri\\_wirdianto@eng.unand.ac.id](mailto:eri_wirdianto@eng.unand.ac.id)

stored until their expiration date, so they must be destroyed.



**Fig. 2.** Total shortage of blood.

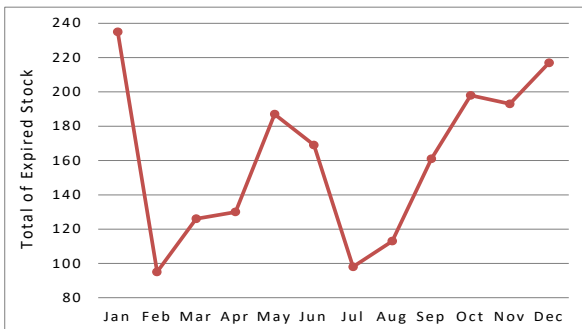

**Fig. 3.** Total of expired blood.

Considering that blood supply, production, and demand are stochastic and having complex interactions among system entities, a discrete-event simulation is determined as a suitable method to mimic the real system [2]. The use of discrete-event simulation on health services has been grown significantly for the last four decades [3,4]. However, from 483 journal papers examined, only 13 addressed the logistics model of health service products where blood is one of its topics [3]. Moreover, in another review article in health care, only 1 out of 211 papers used the discrete-event simulation model to study the blood center [4].

The recent researches related to blood supply have been conducted from different perspectives. The availability of blood at the right time and specified quality have made this topic interesting to discuss. Onggo [5] modeled a hybrid simulation model for the blood supply chain and found that the shortages of blood supply in Low- and Middle-Income countries have caused a high unavoidable death rate, especially for women and children, compared to High-Income countries. In the blood collection process, the blood supply unit could provide two different ways of collection. Therefore, the blood collection strategy has been modeled and simulated by considering fixed and mobile blood collection [6]. Moreover, different characteristics of the blood supply chain in different countries also become challenging issues to solve [5-8].

In this research, a discrete-event simulation model is developed by considering the complex interaction of blood supply, production, and demand in order to determine the relevant blood supply policy to reduce the number of stockouts and overdates to increase service level. The development of a simulation model on the particular system is novel and beneficial to improving PMI UDD Padang's performance.

## 2 Research Method

The main activity of this research was developing the simulation model of blood supply at PMI UDD Padang. Before developing the simulation model, it was essential to understand the system description, conceptual model, and model specification.

### 2.1 System Description

PMI UDD Padang carries out several stages to obtain blood before it is distributed to the recipient. These stages are blood collection and qualification, blood processing, blood storage, and blood distribution. The illustration is presented in Fig. 4.

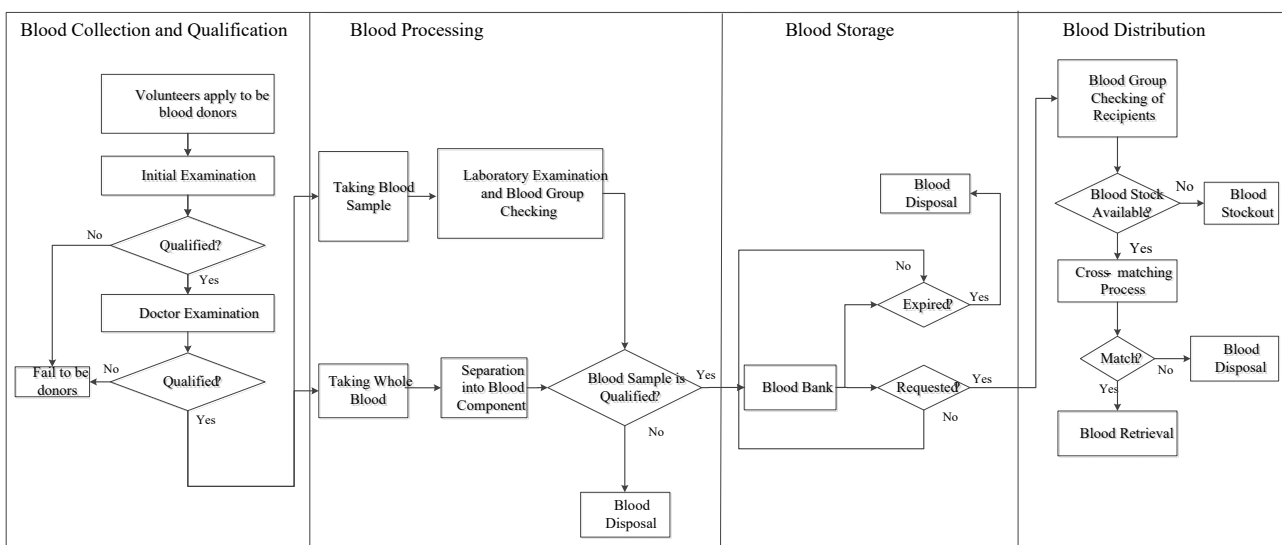

**Fig. 4.** System description of blood inventory at PMI UDD Padang.

## 2.2 Conceptual Model

The simulation model for the blood supply system used the software of Microsoft Excel and Arena. Microsoft Excel was used in the initialization process, while Arena was used in developing simulation models of the existing system [9,10]. The conceptual model of this research can be seen in Fig. 5.

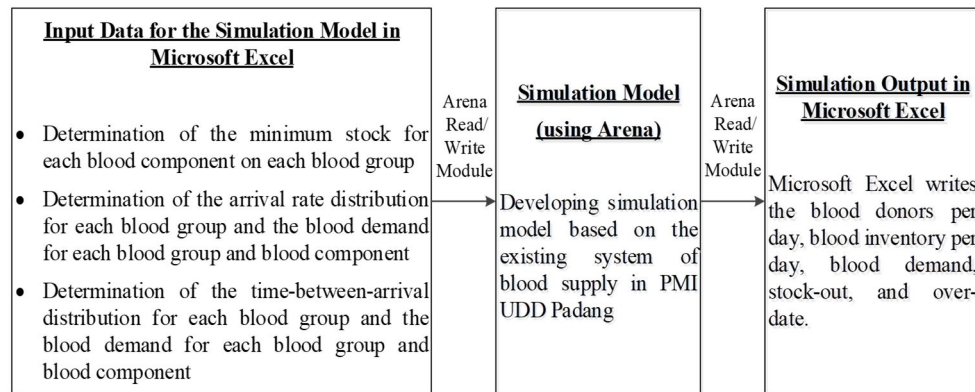

Fig. 5. Conceptual model of the research.

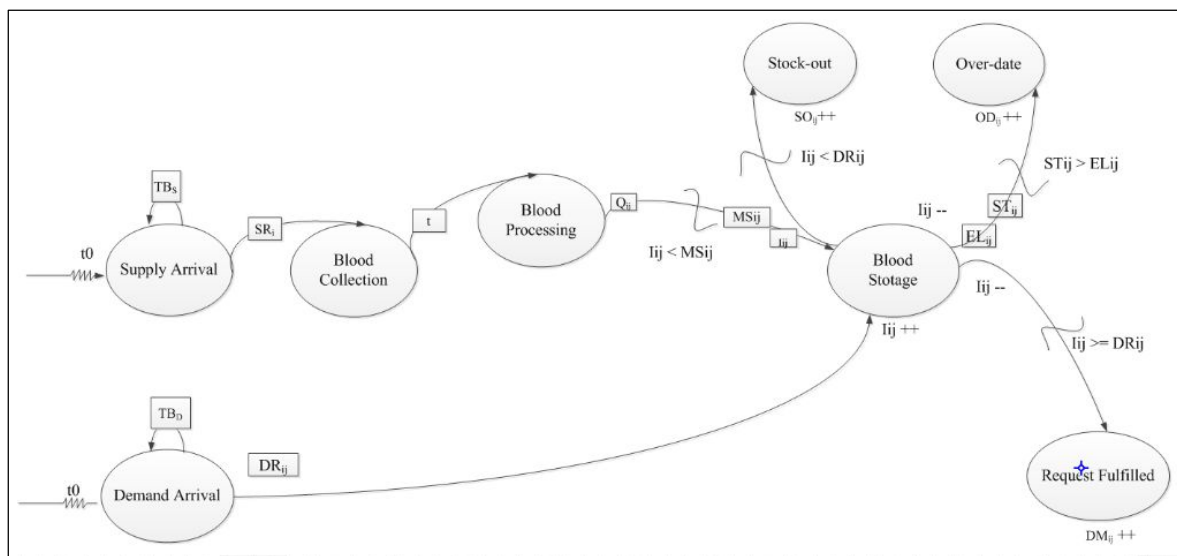

Fig. 6. Event graph of blood supply system at PMI UDD Padang.

Where:

- $TBS$  = Time between arrivals of donors
- $TBD$  = Time between arrivals of demand
- $I_{ij}$  = Total inventory of each blood group and component
- $MS_{ij}$  = Minimum stock of each blood group and component
- $Q_{ij}$  = Total production of each blood type and component
- $DR_{ij}$  = Demanded quantity for each blood type and component
- $SR_{ij}$  = Total donation of each blood type
- $ST_{ij}$  = Storage time of each blood group and component

- $EL_{ij}$  = Expiry limit for each blood type and component
- $SO_{ij}$  = Total stockout of each blood group and component
- $OD_{ij}$  = Number of overdates for each blood group and component
- $DM_{ij}$  = Total fulfilled demand for each blood group and component

## 2.4 Development of Simulation Model

Based on the existing condition, a computer simulation model was created using the Arena software to develop the simulation model of the blood supply system at PMI

UDD Padang. The blood supply system was observed from blood collection and qualification, blood processing, blood storage, and blood distribution. Determination of the blood supply is based on the minimum stock that must be available for each blood component of each blood group. In addition, each blood component also has an expiration date which will be immediately destroyed if it has passed that limit.

### 2.4.1 Input Data

The input data used in the simulation model are the arrival rate of blood, the time between arrivals of blood, the arrival rate of blood demand, and the time between arrivals of blood demand. The distribution used for the two data is discrete. It is because the time interval used in the system is discrete.

As an example, based on historical data, the demand for Blood Component WB of Blood Group A is following DISC ( 0.6438 , 0 , 0.7370 , 1 , 0.8548 , 2 , 0.8959 , 3 , 0.9370 , 4 , 0.9589 , 5 , 0.9671 , 6 , 0.9808 , 7 , 0.9890 , 8 , 0.9918 , 9 , 0.9973 , 10 , 1 , 11), which means that for a particular day probability of demand equals to 0 unit is 0.6438 or demand equals to 1 unit is 0.0932 and so on.

### 2.4.2 Simulation Input and Output

The input of the simulation model read by Microsoft Excel is the minimum stock of each blood component in each blood group. The simulation results of the blood supply model of PMI UDD Padang can also be seen in Microsoft Excel using the Read/Write module. The Read/Write module is used to view the simulation results for all the variables needed for each blood group and component. The variables displayed in the module are the day, the number of incoming blood donations per day, the number of blood that has been processed, the demanded quantity, the fulfilled demand, the number of stockouts, the amount of final inventory, and the number of overdates for each blood component of each blood type. The logic model in this process can be seen in Fig. 7.

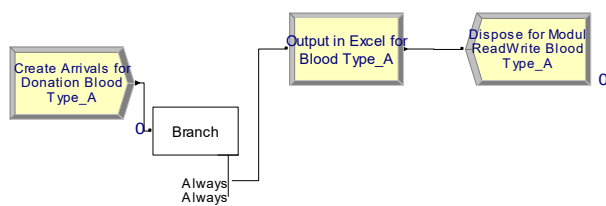

Fig. 7. Logic model of read/write module.

### 2.4.3 Blood Arrival Module

The process that occurs in this module is the process of generating the number of blood arrivals. There is a decision to use a blood bag (triple/double). Every incoming blood will use a triple bag of blood until the triple bag stock requirement is met. Then proceed with the use of a double bag. The modules used in the blood acquirement process are Create – Assign – Route – Station

– Batch. The logic model and modules in this process can be seen in Fig. 8.

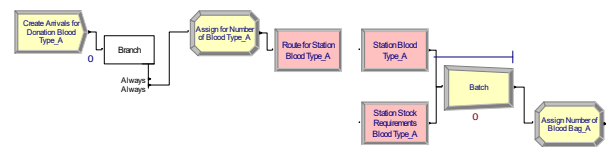

Fig. 8. Logic model of blood arrival module.

### 2.4.4 Blood Stock Determination Module

This requirement of blood is based on the number of stock available and the minimum stock. The formula for determining the need for this blood component are as follows:

- 1) WB Requirement = Max (0, (Minimum Stock A WB - WB Final Stock Amount)). This method is the same for calculating the number of other blood components needed.
- 2) Amount of triple bag requirement = Max ((Total FFP Stock Requirement + AHF Stock Requirement Amount), (TC Stock Requirement + AHF Stock Requirement Amount))
- 3) Number of double bag needs = Max (Number of WB Stock Requirements, (WB Stock Requirements Quantity + (PRC Stock Requirements Amount - Triple Bag Stock Requirements Total))))

The modules used to model this process are Create – Assign – Route. The logic model of this process can be seen in Fig. 9.

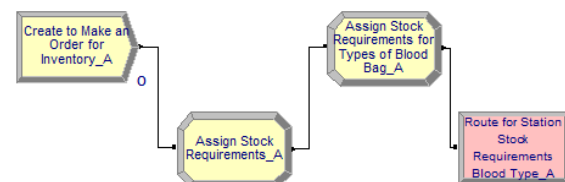

Fig. 9. Logic model of stock determination module.

### 2.4.5 Blood Processing Module

The process that occurs in this section is the separation of whole blood into several blood components. This process is based on the number of stock requirements provided by the blood storage department based on the amount of blood stock in the blood bank. The modules used to model this process are Branch – Assign – Separate – Route. The logic model of this process can be seen in Fig. 10.

### 2.4.6 Blood Storage Module

The processes that occurs are storing production results and determining the final inventory value at the end of each day. The modules used to model this process are Station – Hold – Assign – Branch – Dispose. The logic model of this process can be seen in Fig. 11.

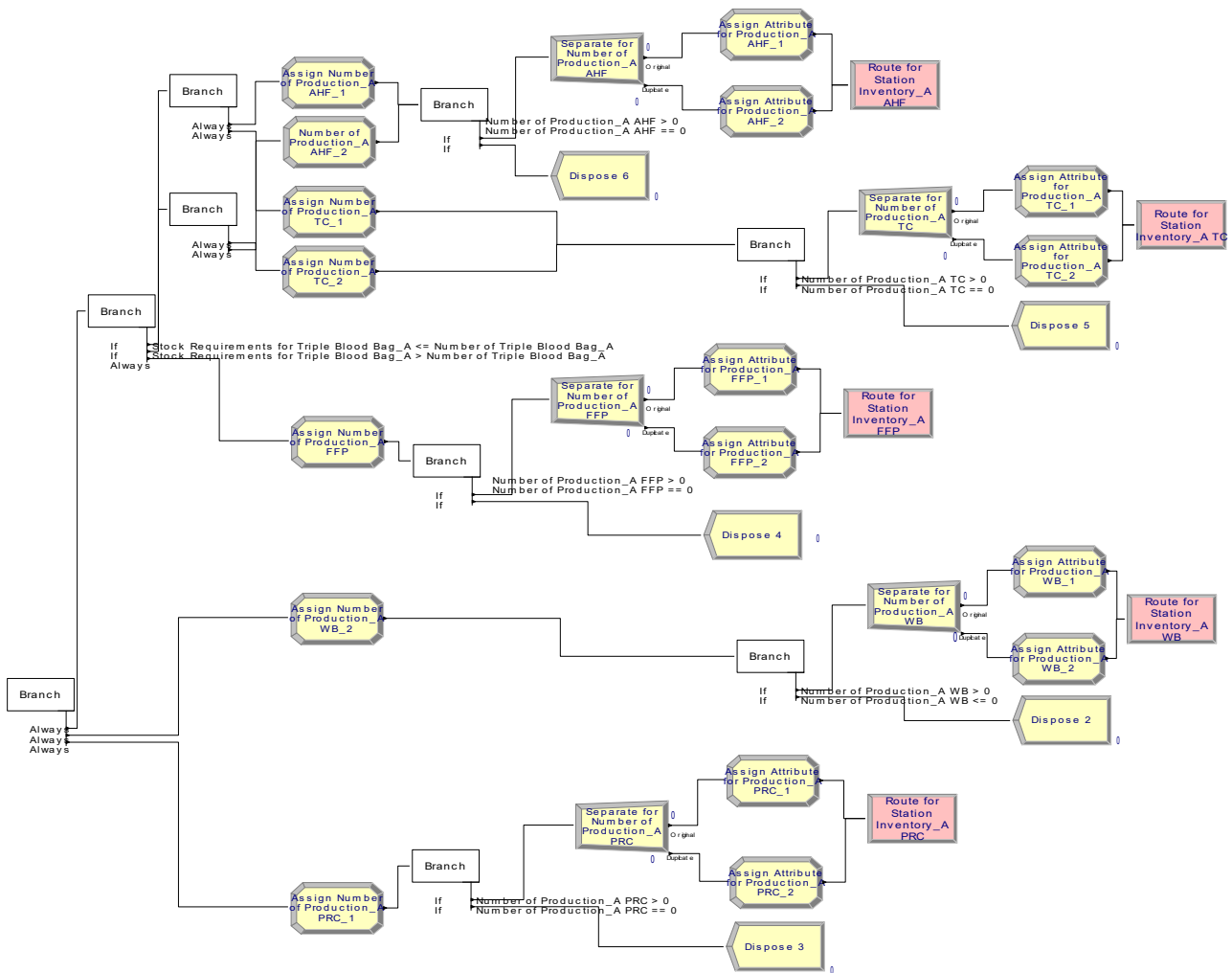

**Fig. 10.** Logic model of the blood processing module.

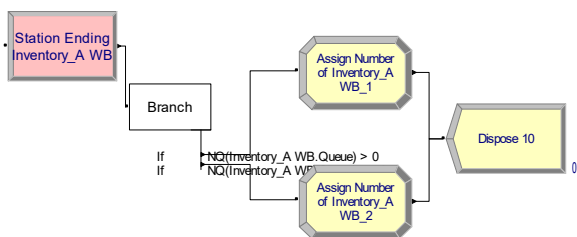

**Fig. 11.** Logic model of the blood storage module.

### 2.4.7 Blood Demand Module

This module works when the demand for blood from the recipient occurs at the blood distribution section. The modules used to model this process are Create – Assign. The logic model and modules in this process can be seen in Fig. 12.

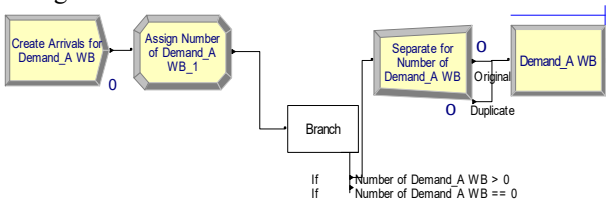

**Fig. 12.** Logic model of blood demand module.

### 2.4.8 Blood Disposal Module

The process of disposing of expired blood is a process that occurs in the storage section by removing blood from storage if the blood has passed the expired time. The formula for determining storage time and the number of overdates in this process are:

- 1) Storage time = TNOW - The first time the blood entered the storage
- 2) Number of overdates = Number of overdates + 1

The modules used to model this process are Assign – Branch – Route – Station – Dispose. The logic model of this process can be seen in Fig. 13.

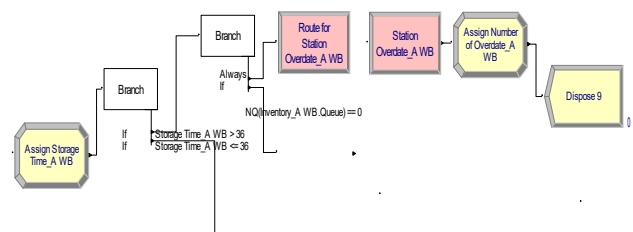

**Fig. 13.** Logic model of blood disposal module.



### 2.4.9 Fulfilled Demand Module

Fulfilled demand is a continuation of blood demand. If the stock is more than the demanded quantity, then the blood will be issued from the storage section, and the calculation of fulfilled demand for each blood component will be carried out. The blood demand will be fulfilled until the end of the day, so the model is also designed to fulfill the demand at the end of the day. The fulfilled demand formula in this process are:

1. Demand is fulfilled if = Demand > 0 and Total Inventory > 0
2. Fulfilled demand = Fulfilled demand + 1

The modules used to model this process are Branch – Batch – Route – Station – Assign. The logic model of this process can be seen in Fig. 14.

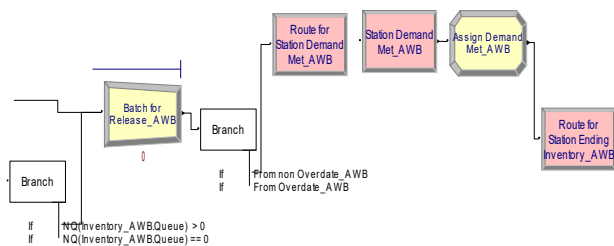

Fig. 14. Logic model of fulfilled demand module.

### 2.4.10 Stockout (Demand Not Fulfilled) Module

Stockout is a continuation of the blood demand. If the stock is less than the demanded quantity, the blood will be issued as much as the number of available stock, while the demand quantity that cannot be fulfilled will be calculated for each blood component.

The formula for determining the decision and calculating the amount of stockout blood in this process are:

- 1) Stockout occurs if = Demand > 0 and total inventory = 0 or Demand > 0 and total inventory > 0 (overdate blood)
- 2) Total stockout = Total stockout + 1

The modules used to model this process are Branch – Assign – Dispose. The logic model of this process can be seen in Fig. 15.

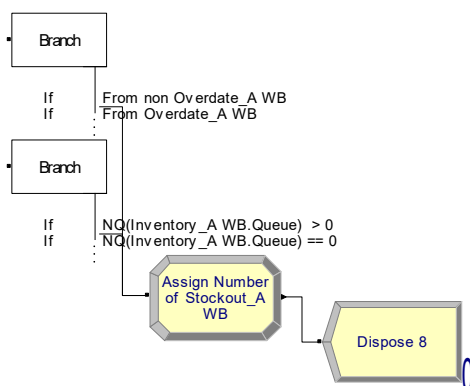

Fig. 15. Logic model of stockout module.

## 3 Result and Discussion

### 3.1 Simulation Model Verification and Validation

Verification is the stage to determine whether the computer simulation program has been made as expected [11]. The verification of this simulation model has been done by ensuring that the model has all the components specified during the system identification phase and does not experience errors when running.

Validation is a process to see whether the model is appropriate or similar to the actual system conditions to represent the whole system [12]. The model is validated using the black box method, which compares the simulation results with the actual system. The statistical test was carried out using SPSS software. The results of the paired sample t-tests are shown in Table 1.

Table 1. The result of paired sample t-test using SPSS.

Simulation - Actual	Paired Differences	Mean	Std. Dev.	Std. Err. Mean	95% Confidence		t	df	Sig. (2-tailed)
					Lower	Upper			
					Pair-1 Donors Arrival	- 11,65			
Pair-2 Production	- 10,41	252,80	16,32	-42,56	21,73	-0,638	239	0,524	
Pair-3 Stock-out	10,18	130,39	16,83	-23,50	43,87	0,605	59	0,548	
Pair-4 Over-date	19,25	115,14	33,24	-53,90	92,40	0,579	11	0,574	
Pair-5 Demand	-1,56	264,54	17,08	-35,2	32,08	-0,092	239	0,927	

Table 1 shows that there is no significant difference between the simulation results and the actual system, so it is concluded that the simulation model is valid and can be used to represent the actual system.

### 3.2 Initial Simulation Result

The verified and validated simulation model was run for 366 days with ten replications based on the normal approximation method. The initial minimum stock policy decided by PMI UDD Padang is shown in Table 2.

The simulation output is based on actual conditions. The number of stockouts (SO) and overdates (OD) for each blood component of each blood group can be seen in Table 3.

Table 2. Initial minimum stock policy at PMI UDD Padang.

Bl. Comp.	WB	PRC	FFP	TC	AHF
A	5	30	20	30	30
B	30	5	30	10	30
AB	30	30	5	30	20
O	20	30	10	5	30

Table 3. Output of initial simulation model.

Bl. Comp.	WB	PRC	FFP	TC	AHF	Total					
Bl. Group	SO	OD	SO	OD	SO	OD	SO	OD	SO	OD	Total
A	10	103	353	0	1	0	1654	4	3	0	2128
B	5	695	137	0	0	0	1072	2	1	0	1912
AB	32	14	408	0	0	0	482	93	1	9	1039
O	4	1235	103	0	2	0	2347	0	0	0	3691
Total	51	2047	1001	0	3	0	5555	99	5	9	8770
Total SO	6615										
Total OD	2155										

### 3.3 Experimentation Scenarios

The large numbers of stockouts and overdates are the problem at PMI UDD Padang. Therefore, the solution is to determine the production quantity for each blood component to minimize it. The minimum stock policy influences the production quantity of each blood component at PMI UDD Padang and the number of blood collected every day. In this study, the experiment was divided into two scenarios: when the blood demand is assumed to be the same as historical data and when the blood demand increases at the population growth rate.

Based on data from the Central Bureau of Statistics of the City of Padang, the population increases by 1.38% on average annually. So that, it is concluded that the blood demand will also increase in that percentage. The simulation output with increased demand under initial minimum stock policy can be seen in Table 4.

**Table 4.** Output of simulation model with increased demand under initial minimum stock policy.

Bl. Comp.	WB		PRC		FFP		TC		AHF		Total
	SO	OD	SO	OD	SO	OD	SO	OD	SO	OD	
A	11	83	427	0	1	0	1684	4	3	0	2213
B	5	658	147	0	0	0	1088	2	1	0	1901
AB	32	14	409	0	0	0	482	93	1	9	1040
O	4	1101	125	0	2	0	2400	0	0	0	3632
Total	52	1856	1108	0	3	0	5654	99	5	9	8786
Total SO	6822										
Total OD	1964										

In this simulation model, there are three things that will affect the blood supply system, which are blood demand, minimum stock policy, and the number of donors. So the scenarios were prepared based on these three things to obtain alternative policies related to the minimum stock policy and efforts to increase the number of donors when the condition of blood demand is the same as historical data and the condition of blood demand increases by population growth. The criteria used to select policy alternatives are the smallest stockout and overdate generated by the designed scenarios, which are shown in Fig. 16.

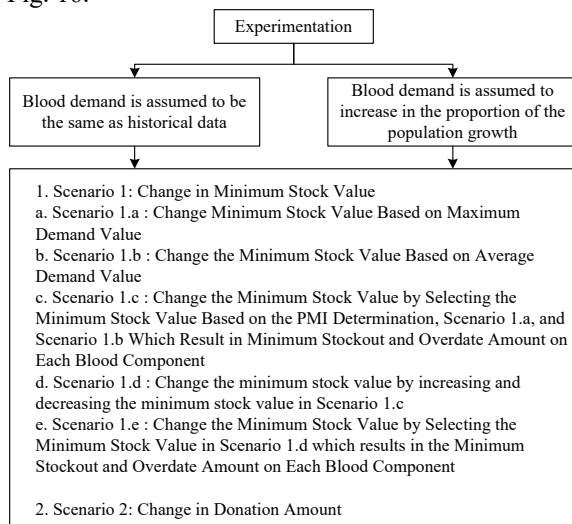

**Fig. 16.** The designed scenario of the simulation.

The results obtain from running these scenarios are explained below:

1. Under the condition of constant blood demand.

The selected minimum stock policy is shown in Table 5. Table 6 shows SO and OD consequences for that policy under the conditions that (i) the number of donors similar to that of the last year and (ii) the number of donors increases by 10% from last year (this 10% was chosen as the best percentage obtained).

**Table 5.** The chosen stock minimum policy under the condition of constant blood demand.

Bl. Comp.	WB	PRC	FFP	TC	AHF
A	1	3	30	56	27
B	1	3	30	51	30
AB	1	1	30	21	13
O	1	15	32	70	15

**Table 6.** Output of simulation model under the condition of constant blood demand.

Bl. Comp.	WB		PRC		FFP		TC		AHF		Total
	SO	OD	SO	OD	SO	OD	SO	OD	SO	OD	
A	17	75	332	0	1	0	194	102	5	0	726
A + 10%	6	889	76	0	1	0	148	106	4	0	1230
B	8	531	111	0	0	0	117	113	1	0	881
B + 10%	4	1531	25	0	0	0	85	118	1	0	1764
AB	37	7	384	0	0	0	205	234	4	2	873
AB + 10%	12	164	103	0	0	0	175	254	3	2	713
O	8	1259	104	0	0	0	118	88	11	0	1588
O + 10%	5	2720	40	0	0	0	81	92	9	0	2947

From Table 6, it can be concluded that if the amount of blood demand remains constant, then the minimum stock policy used is as in Table 5, and the number of donors for blood group AB should be increased by 10% while for other blood groups remain the same. This proposed scenario will reduce stockout and overdate on all blood groups.

The comparison of stockout and overdate before and after scenarios designed for constant blood demand are illustrated in Fig. 17.

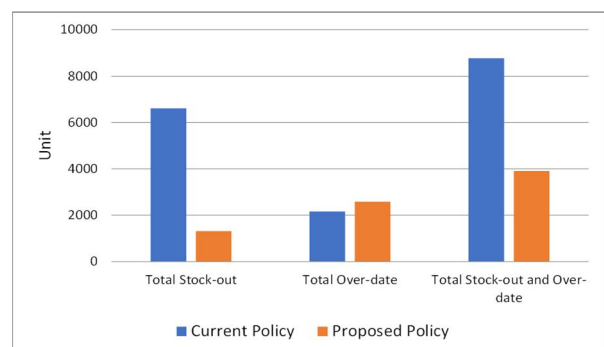

**Fig. 17.** The comparison of stockout and overdate before and after scenarios designed for constant blood demand.

2. Under the condition of increased blood demand.

The selected minimum stock policy is shown in Table 7. Table 8 shows SO and OD consequences for that policy under the conditions that (i) the number of donors similar to that of the last year and (ii) the number of donors increases by 10% from last year (this 10% was chosen as the best percentage obtained).

**Table 7.** The chosen stock minimum policy under the condition of increased blood demand.

Bl. Comp.	WB	PRC	FFP	TC	AHF
Bl. Group					
A	1	3	30	57	27
B	1	3	30	47	30
AB	1	1	30	21	13
O	1	12	32	71	15

**Table 8.** Output of simulation model under the condition of increased blood demand.

Bl. Comp.	WB		PRC		FFP		TC		AHF		Total
	SO	OD	SO	OD	SO	OD	SO	OD	SO	OD	
A	20	54	339	0	1	0	198	109	5	0	726
A + 10%	6	785	81	0	1	0	151	114	4	0	1142
B	8	491	120	0	0	0	158	82	1	0	860
A + 10%	4	1478	26	0	0	0	118	85	1	0	1712
AB	37	7	384	0	0	0	205	234	4	2	873
A + 10%	12	164	103	0	0	0	175	254	3	2	713
O	9	1123	127	0	0	0	124	94	7	0	1484
O + 10%	5	2556	44	0	0	0	86	99	9	0	2799

From Table 8, it can be concluded that if the amount of blood demand remains constant, then the minimum stock policy used is as in Table 7, and the number of donors for blood group AB should be increased by 10% while for other blood groups remain the same as last year. This proposed scenario will reduce stockout and overdate on all blood groups.

The comparison of stockout and overdate before and after scenarios designed for increased blood demand are illustrated in Fig. 18.

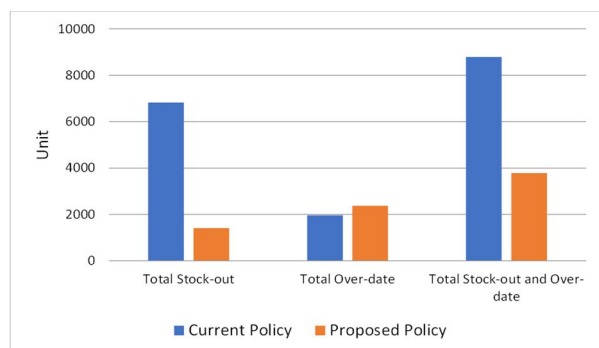

**Fig. 18.** The comparison of stockout and overdate before and after scenarios designed for increased blood demand.

Various scenarios can be generated using this developed simulation model to obtain feasible alternatives of blood supply systems in various conditions.

According to results obtained from model simulations, it is suggested that PMI UDD Padang increases the stock of blood group AB by 10%, which has been consistently stockout. Considering that the number of donors of blood group AB is rare, PMI UDD Padang needs to actively identify people who have that blood group in the community. They need to be socialized about the importance of blood availability and encouraged to donate their blood regularly to enhance health service quality in the community.

## 4 Conclusion

This research produces a simulation model that can represent the actual system at PMI UDD Padang. This simulation model is designed by considering the processes that occur at PMI UDD Padang. The processes are the donation arrival process, the blood demand arrival process, the process of determining the need for the amount of blood production, the blood processing, the blood storage, the blood distribution to fulfill the demand, the blood disposal, and the process of calculating the stockout. The proposed blood supply policies that can increase service levels are found at the minimum stock policy obtained and the increase donations to blood group AB by 10%.

The blood supply is closely related to the availability of disposable medical equipment to support the blood supply process. It is recommended to design an inventory planning policy to ensure the availability of disposable medical equipment at minimum inventory cost.

The authors would like to thank the Industrial Engineering Department, Faculty of Engineering, Andalas University for supporting this publication through the 2021 Publication Grant. They also express their gratitude to the LPPM of Andalas University, Indonesia.

## References

1. M. Asadpour, O. Boyerhasani, and R. Tavakkoli-Moghaddam, in Proceeding of the 1st International Conference on Challenges and New Solutions in Industrial Engineering and Management and Accounting, 16 July 2020, Adib Mazandaran, Iran, (2020)
2. M. Doneda, S. Yalçındag, I. Marques, and E. Lanzarone, Vox Sang. (2021)
3. S. Liu, Y. Li, K. P. Triantis, H. Xue, and Y. Wang, MDM Plcy. & Pract. **5** (1), 1 (2020)
4. X. Zhang, BMC Health Serv. Res. **18** (1), 687 (2018)
5. B. S. Onggo, in Proceeding of the Winter Simulation Conference, 7-10 December 2014, Savannah, GA, USA, (2014)
6. E. Alfonso, X. Xie, V. Augusto, and O. Garraud, Health Care Manage. Sci. **15**, 63 (2012)
7. J. Blake and K. McTaggart, in Proceeding of the 6th International Conference on Simulation and Modeling Methodologies, Technologies and



- Applications, 29-31 July 2016, Lisbon, Portugal, (2016)
8. A. Mansur, I. Vanany, and N. I. Arvitrida, in Proceeding of the 9th International Conference on Industrial Engineering and Operations Management, 5-7 March 2019, Bangkok, Thailand, (2019)
  9. W. D. Kelton, R. P. Sadowski, and N. B. Zupick, *Simulation with Arena*, 6th ed. (McGraw-Hill Education, New York, 2015)
  10. T. Altiok and B. Melamed, *Simulation Modeling and Analysis with Arena*. (Elsevier, Burlington, 2007)
  11. C. A. Chung, *Simulation Modeling Handbook: A Practical Approach*. (CRC Press LLC, Boca Raton, 2004)
  12. M. D. Rossetti, *Simulation Modeling and Arena*, 2nd ed. (John Willey & Sons, Inc., New Jersey, 2016).