

# The influence of the network asymmetry on the settings and sensitivity of an earth fault protection using higher harmonics

Lubomir Marciniak<sup>1,\*</sup>, and Mateusz Piątek<sup>1</sup>

<sup>1</sup>Institute of Electric Power Engineering, Technical University of Czestochowa, Aleja Armii Krajowej 17, 42-200 Czestochowa, Poland

**Abstract.** Detection of high resistance earth faults in medium voltage networks is an important problem due to ineffectiveness of traditional earth fault protections. Such short circuits can be detected by the criterion of a reactive power of higher harmonics for zero sequence current and voltage. The main problem is determination of the power setting value in the protection, which depends on the asymmetry of phase-to-earth capacitances and higher harmonics in supply voltages, which are generated by non-linear loads. The intensive tests of the asymmetry of the zero sequence currents and voltages for harmonics and their reactive power have been carried out in 15 kV compensated network as a function of all relevant parameters, i.e.: maximum capacitance deviation of the network and protected line, percentage content of harmonics in supply voltages, capacitive current of the network and the line. It has been shown that third harmonics of the zero sequence voltage and current are the best suited for practical use, since the asymmetry reactive power of these components is the smallest among the considered harmonics and the protection sensitivity will be the highest.

## 1 Introduction

The vast majority of earth fault disturbances in medium voltage (MV) networks, especially in overhead lines, are short-circuits with a fault resistance from a few ohms to several thousand ohms [1–3]. There are also short circuits with a fault resistance of several tens kilohms [1]. The detection of a high resistance fault poses many problems due to low measured values of zero sequence current and voltage comparable with the noise level, asymmetry signals and errors of measurement transformers.

Currently, in compensated networks for the identification of a faulted line, earth fault protections are most often applied that use the fundamental harmonics of the zero sequence current and voltage [1, 2]. In the phase of research and experimental applications there are protections using:

- higher harmonics of the zero sequence current and voltage [1, 4-6];

---

\* Corresponding author: [lubmar@el.pcz.czest.pl](mailto:lubmar@el.pcz.czest.pl)

- modern signal processing methods, such as modified Fourier transform, wavelet transform, artificial neural networks [1, 3, 7-10].

In Poland until recently, directional relays based on phase comparators were used. They use as basic measuring quantities the fundamental harmonics of the zero sequence current and voltage [1, 2]. For the compensated network, directional relays with cosine tripping characteristic (directional, zero sequence active current or active power) have been recommended. These relays are successively replaced by the protection responsive to the zero sequence admittance and its active component, i.e. the conductance [2]. To ensure correct operation of these protections, the active current forcing automatics is commonly used to force an active current in the short circuit. The operation of a directional and admittance protection depends on the fulfillment of the voltage criterion for a zero sequence component. In this case, the tripping voltage of the voltage relay is chosen above the natural network asymmetry voltage. For a compensated network this comes down to fulfill the following condition [2]:

$$U_{0set} \geq k_b U_{as} / K_{U0} \quad (1)$$

where:  $U_{0set}$  – setting value for the zero sequence voltage criterion,  $U_{as}$  – maximum value of the network asymmetry voltage,  $k_b$  – safety factor,  $K_{U0}$  – transformation ratio of a zero sequence voltage filter.

The analysis performed in [2, 11] shows that the value of the network asymmetry voltage for the zero sequence component depends on the resulting phase capacitance unbalance  $U_{asC}$ , phase conductance unbalance  $U_{asG}$ , asymmetry voltage of the supply source  $E_0$ , compensation detuning ratio  $s$ , damping coefficient for zero sequence components  $d_0$ , and can be evaluated from equation:

$$\underline{U}_{0as} = \underline{U}_{asG} + \underline{U}_{asC} + \underline{E}_0 = - \frac{\sum_{i=1}^3 (\underline{E}_{Li} G_{0Li})}{3\omega_0 C_0 (d_0 - js)} - \frac{\sum_{i=1}^3 (\underline{E}_{Li} C_{0Li})}{3C_0 (d_0 - js)} + \underline{E}_0 \quad (2)$$

where:  $\underline{E}_{Li}$  – phase voltages of the supply source,  $\underline{E}_0 = (\underline{E}_{L1} + \underline{E}_{L2} + \underline{E}_{L3})/3$  – zero sequence source voltage;  $G_{0Li}$ ,  $C_{0Li}$  – phase-to-earth conductances and capacitances of the network,  $G_0 = (G_{0L1} + G_{0L2} + G_{0L3})/3$  – zero sequence network conductance,  $C_0 = (C_{0L1} + C_{0L2} + C_{0L3})/3$  – zero sequence network capacitance,  $\omega_0$  – the angular frequency for the fundamental harmonic.

The asymmetry of the source voltages is usually negligible small. The asymmetry voltage caused by conductance is also small. Hence the conclusion that the asymmetry voltage for zero sequence components depends primarily on the asymmetry of phase-to-earth capacitances and the degree of the compensation detuning  $s$ . In compensated networks with a large share of overhead lines, it is necessary to apply quite large voltage setting values, at the level of 15÷25% of the voltage rating [2], which has a negative effect on the protection sensitivity. Due to the high value of  $U_{0set}$ , classical earth fault protections using fundamental harmonics of the zero sequence currents and voltages are able to detect short circuits with relatively small value of a fault resistance, usually not exceeding 2 k $\Omega$ .

## 2 The criterion of the reactive power of higher harmonics of zero sequence current and voltage

To detect high-resistance earth faults, unconventional methods must be used. In works [4, 5], it was shown that such short-circuits can be detected by the reactive power criterion

for higher harmonics of zero sequence current and voltage. This criterion comes down to the main dependence:

$$Q_{0hset} \geq k_b Q_{0h1} = k_b \operatorname{Im}(\underline{U}_{0h} \underline{I}_{Eh1}^*) \quad (3)$$

where:  $Q_{0hset}$  – setting value of a reactive power,  $Q_{0h1}$  – asymmetry reactive power for zero sequence current and voltage harmonics of the line,  $\underline{U}_{0h}$  – phasor of a zero sequence voltage asymmetry for harmonics,  $\underline{I}_{Eh1}$  – phasor of an earth current asymmetry for harmonics in the protected line.

Voltage and earth current asymmetry for harmonics in a protected line during normal work can be estimated from approximate dependencies [9]:

$$\underline{U}_{0h} = -\frac{E_L k_{hp} (d_{0h} + j)(C_{0L1} + \underline{a}^2 C_{0L2} + \underline{a} C_{0L2})}{100 \cdot 3C_0(d_{0h} - js_h)} \quad (4)$$

$$\underline{I}_{Eh1} = -\frac{E_L k_{hp}}{100} \omega (d_{0h} + j) \left[ \frac{a_1 (d_{0h} + j) A}{(d_{0h} - js_h)} - B \right]; \quad (5)$$

$$A = (C_{0L1} + \underline{a}^2 C_{0L2} + \underline{a} C_{0L2}); \quad B = (C_{01L1} + \underline{a}^2 C_{01L2} + \underline{a} C_{01L2})$$

where:  $E_L$  – the nominal phase voltage of the supply source,  $k_{hp}$  – percentage of the harmonic content in the supply voltage,  $C_{0Li}$  – phase-to-earth line capacitances,  $a_1 = C_{01}/C_0$  – share of a line in the network zero sequence capacitance,  $C_{01} = (C_{01L1} + C_{01L2} + C_{01L3})/3$  – zero sequence capacitance of the line,  $d_{0h} = d_0/n_h$  – damping coefficient for harmonics of order  $n_h$ ,  $s_h$  – compensation detuning factor for harmonics,  $\omega$  – angular frequency for harmonic,  $\underline{a} = 1^{j2\pi/3}$  – complex rotation operator.

The detuning factor for harmonics  $s_h$  can be expressed by the detuning factor for the fundamental harmonic  $s$  and the harmonic number  $n_h$  from the equation:

$$s_h = (s - n_h^2 + 1) / n_h^2 \quad (6)$$

This factor is already close to  $-1$  for the third harmonic ( $s_h \cong -0.9$  for  $n_h = 3$ ), so the impact of compensation on  $U_{0h}$ ,  $I_{Eh}$  and  $Q_{0h}$  will be small. For higher harmonics, the compensated network will behave similar to a network with an isolated neutral point.

In accordance with applicable regulations regarding the quality of the power supply voltage [12], the level of harmonics in the source voltage, determined by the harmonic content coefficient  $k_h$  depending on the harmonic order, should not exceed  $1.5 \div 6\%$  of the fundamental harmonic and the total harmonic distortion coefficient  $THD = 8\%$ .

Compensation of an earth current, used for the fundamental harmonic, will have a small influence on the voltage and current asymmetry for the higher harmonics. Therefore, small values of the asymmetry reactive power  $Q_{0h1}$  should be expected and high protection sensitivity as well.

The estimation of  $U_{0h}$ ,  $I_{Eh}$  and  $Q_{0h}$  is therefore necessary to determine the setting values of the protection with the criterion of reactive power of higher harmonics, to ensure the correct operation of such a protection and to assess its sensitivity.

### 3 Assessment of the influence of the capacitive asymmetry on the harmonics of zero sequence current and voltage and the reactive power of these harmonics

#### 3.1 Model of the system for testing asymmetry

To investigate the effect of capacitance asymmetry on the value of zero sequence current, voltage and reactive power asymmetry for harmonics, a simulation model of a compensated MV network in Matlab/Simulink was developed (Fig. 1).

The model contains a *Power\_source* blok with nominal voltage  $U = 15 \text{ kV}$  and impedance  $Z_S \cong X_S = 2 \text{ } \Omega$ , three-phase source of current for harmonics *Source Ih*, simplified (due to the ease of parameterization) network model in the form of masked block *Yo*, compensation coil *RdLd* and measuring systems. The network model contains only phase admittance  $Y_{01Li}$  of the separated for testing line, and admittance of the remaining part of the network  $Y_{02Li}$  (phase-to-earth capacitances and conductances). In the *Yo* block you can set the capacitance of the network  $C_0$ , network damping coefficient  $d_0$ , share of the line in the network capacitance  $a_1$ , maximum deviation of the network capacitance in per cent  $\Delta C_{0p}$ , maximum deviation of the line capacitance in per cent  $\Delta C_{0lp}$ . The block allows modeling the capacitance and conductance asymmetry, proportional to capacitive one. The research was limited to the worst case of asymmetry for which the setting value of protection will be the highest. As a result of preliminary simulation tests it was found that this type of asymmetry corresponds to the following deviations of phase capacitances and conductances in the network:

$$\begin{aligned} C_{0L1} &= C_0 + \Delta C_0; & C_{0L2} &= C_0; \\ G_{0Li} &= d_0 \omega_0 C_{0Li}; & (i = 1, 2, 3) \end{aligned} \tag{7}$$

where:  $\Delta C_0 = C_{0L} - C_0$  – maximum deviation one of the three phase capacitances from the average value,  $G_{0Li}$  – phase conductances of the network;  $\omega_0$  – the angular frequency for the fundamental harmonic.

Deviation  $\Delta C_0$  can be positive and then phase *L1* will have the largest capacitance or negative – phase *L1* will have the lowest capacitance. In the same way, the asymmetry of the separated line was also set.

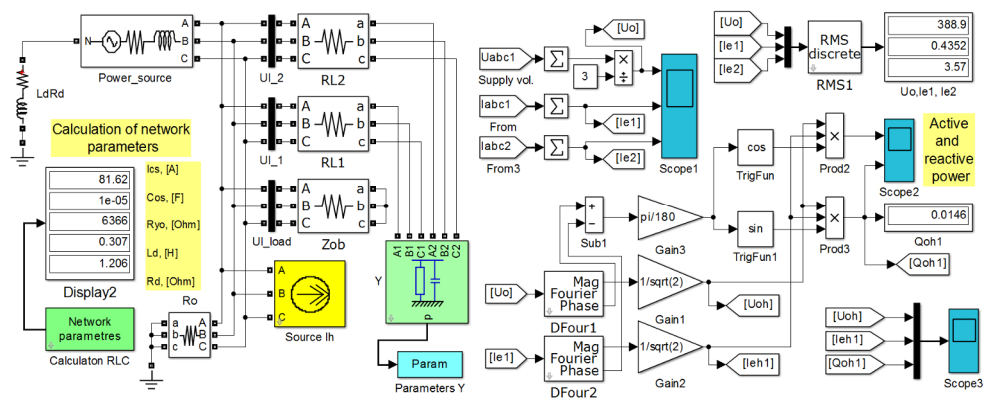

**Fig. 1.** Model of the system for testing asymmetry.

Effective values of the asymmetry voltage for the zero sequence  $U_{0h}$  and the asymmetry earth current  $I_{Eh1}$  were measured by means of *DFour1* and *DFour2* blocks realizing a discrete Fourier transform for a given harmonic in a window with the length  $T_w$  of one cycle of the fundamental harmonic (20 ms) at the sampling frequency  $f_p = 2$  kHz. The asymmetry reactive power  $Q_{0h1}$  was determined on the basis of voltage and current phasor parameters, sine function (*TrigFun1* block) and simple mathematical operations. The model contains a number of blocks for the visualization and export of measurement data.

### 3.2 Research on the impact of the capacitive asymmetry on the zero sequence asymmetry current, voltage and reactive power for current and voltage harmonics

First, the dependence of the asymmetry voltage for harmonics numbered  $n_h = 3, 5, 7$  and  $9$  on the capacitance deviation  $\Delta C_{op}$  in the system with the following parameters has been tested: network capacitive current  $I_{CS} = 100$  A, capacitive current of the line  $I_{C1} = 5$  A, detuning factor  $s = 0.1$ , damping coefficient  $d_0 = 0.05$ , harmonic content coefficient  $k_{hp} = 5\%$ . Figure 2 shows the results of these tests.

Figure 2 shows, that the condition of the asymmetry voltage for any harmonic is the occurrence of the capacitive deviations of the whole network. The asymmetry voltage for harmonics  $U_{0h}$  depends linearly on the maximum deviation of the phase-to-earth capacitance of the network  $\Delta C_{op}$ . It is the smallest for the third harmonic for any value  $\Delta C_{op}$  and non-linearly increases with increasing harmonic order  $n_h$ .

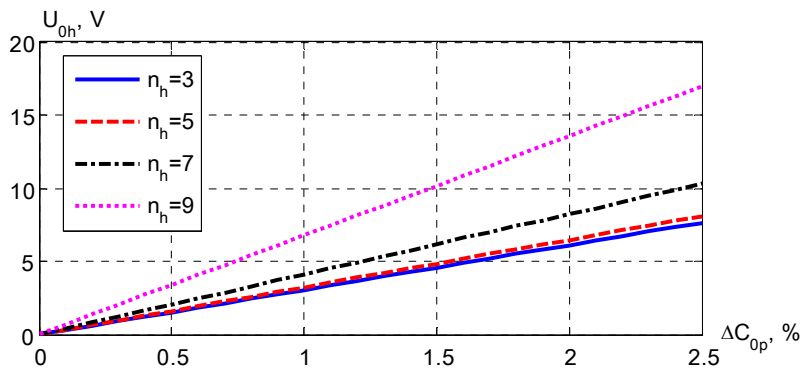

**Fig. 2.** Dependencies of the asymmetry voltage  $U_{0h}$  for harmonics  $n_h = 3, 5, 7$  and  $9$  vs. the maximum phase capacitance deviation of the network  $\Delta C_{op}$ .

The dependence of voltage on frequency results from the impact of the system reactance, which increases proportionally to the frequency and for the ninth harmonic equals  $18 \Omega$ . In the simulation model this reactance is included, whereas in the simplified formula (4) it was omitted. The simulation tests show that in calculations  $U_{0h}$  for higher order harmonics, it is also necessary to take into account the system reactance.

Figures 3 and 4 present the relationship of the asymmetry current  $I_{Eh1}$  and the asymmetry reactive power  $Q_{0h1}$  of the line for harmonics as a function of the maximum capacitance deviation of the line  $\Delta C_{01p}$ . They were obtained in a system with the parameters as above, with a constant value of the capacitive network asymmetry  $\Delta C_{op} = 1\%$ . The current  $I_{Eh1}$  and reactive power  $Q_{0h1}$  depend practically linearly on the maximum capacitance deviation of the line. The condition of the appearance of the asymmetry current and power is the difference between the capacitance asymmetry of the line and capacitance asymmetry of the network  $\Delta C_{01p} - \Delta C_{op}$ . The values  $I_{Eh1}$  and absolute values  $Q_{0h1}$  grow

directly proportional to the difference  $\Delta C_{01p} - \Delta C_{0p}$ . The lowest values  $I_{Eh1}$  and absolute values  $Q_{0h1}$  occur for the third harmonic. They grow non-linearly with increasing harmonic number. The non-linear dependencies  $Q_{0h1}$  as a function of frequency  $f$  were shown in Figure 5. They were obtained with given parameters  $\Delta C_{0p} = 1\%$ ,  $\Delta C_{01p} = 2\%$  and other system parameters as above.

In the case when the line and network capacitance deviations are of the same character, and the absolute difference of their values  $|\Delta C_{01p}| - |\Delta C_{0p}| > 0$ , then the reactive power is positive  $Q_{0h1} > 0$  and its value will have a direct impact on the protection adjustment.

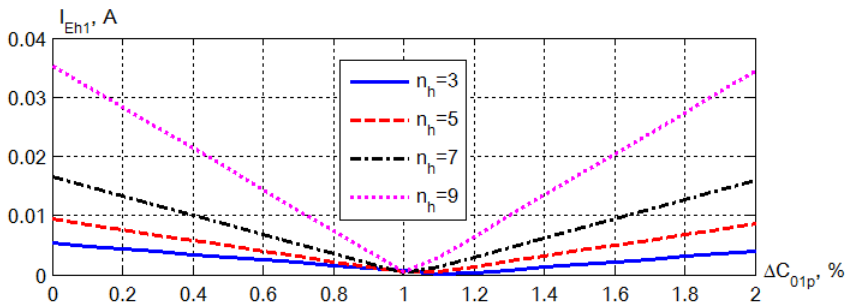

**Fig. 3.** Dependencies of the asymmetry current  $I_{Eh1}$  for harmonics vs. the maximum capacitance deviation of the line  $\Delta C_{01p}$  in the case where  $\Delta C_{0p} = 1\%$ .

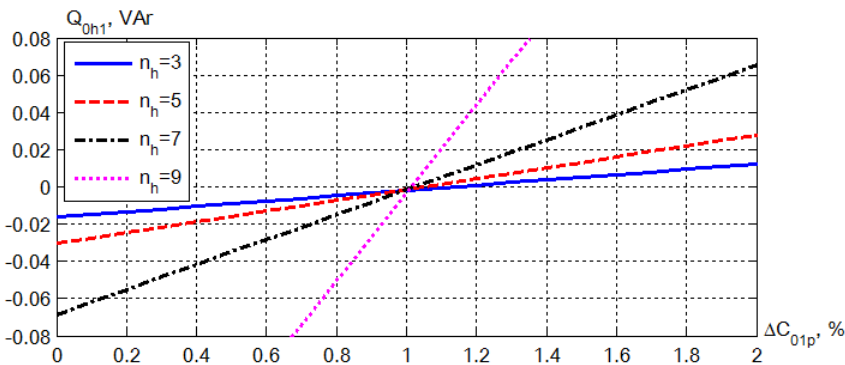

**Fig. 4.** Dependencies of the asymmetry reactive power  $Q_{0h1}$  for harmonics vs. the maximum capacitance deviation of the line  $\Delta C_{01p}$  in the case where  $\Delta C_{0p} = 1\%$ .

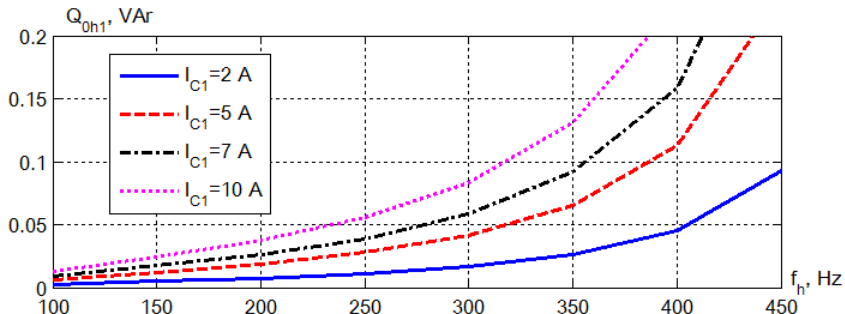

**Fig. 5.** Dependencies of the asymmetry reactive power  $Q_{0h}$  for harmonics as a function of frequency  $f$  for the line with given capacitive currents  $I_{C1}$  in the case where:  $\Delta C_{01p} = 2\%$ ,  $\Delta C_{0p} = 1\%$ .

Figures 2 to 5 clearly show that for the detection of earth faults, the criterion using the reactive power of the third harmonics of zero sequence current and voltage  $Q_{031}$  is best

suit. The asymmetry reactive power for third harmonics is the smallest, and, as shown in [4–6], the non-linear resistance of the earth fault, especially an arc resistance [13–16], generates mainly the third harmonics of the zero sequence current and voltage. The protection using criterion  $Q_{031}$  will have the lowest setting and the highest sensitivity.

In connection with the above conclusion, further analysis was limited to the asymmetry reactive power for the third harmonics of current and voltage. This power depends not only on the capacitance asymmetry of the line and the network, but also on the capacitive current of the network  $I_{CS}$ , the capacitive current of the line  $I_{C1}$  and the percentage content of the third harmonic voltage in the supply voltage  $k_{3p}$ .

Figure 6 presents a family of characteristics of reactive power of the line  $Q_{031}$  versus the capacitive current of the line  $I_{C1}$  for several  $k_{3p}$  values. They were obtained in a system with the following parameters:  $I_{CS} = 100$  A,  $s = 0.1$ ,  $d_0 = 0.05$ ,  $\Delta C_{01p} = 2\%$ ,  $\Delta C_{0p} = 1\%$ . As it can be seen, reactive power grows linearly in the function  $I_{C1}$  (line capacitance) and it is the higher, the higher is percentage content of the third harmonic of voltage  $k_{3p}$ . In overhead lines, where the capacitance asymmetry can reach up to 2.5%, the capacitive current usually does not exceed 5 A and the asymmetry power  $Q_{031}$  will be small, not more than 30 mVar even with a very high value  $k_{3p} = 8\%$ .

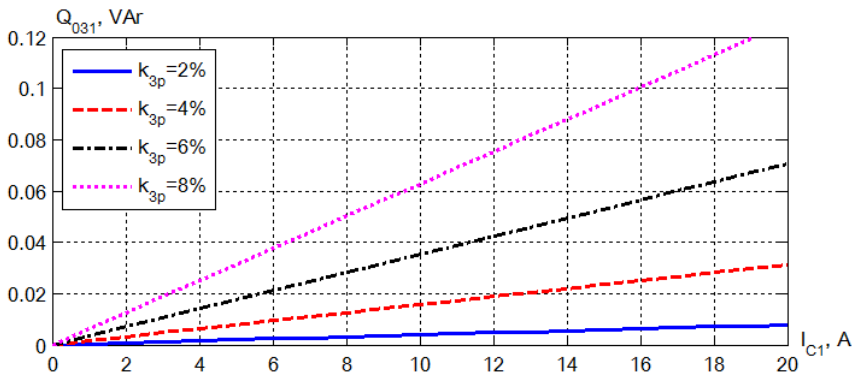

**Fig. 6.** Dependencies of the asymmetry reactive power  $Q_{031}$  for the current and voltage third harmonics as a function of the capacitive current of the line  $I_{C1}$  for several  $k_{3p}$  values.

The asymmetry reactive power of the line depends to a small extent on the capacitive current of the network  $I_{CS}$ , as evidenced by the characteristics presented in Figure 7, and obtained in a system with the following parameters:  $\Delta C_{01p} = 2\%$ ,  $\Delta C_{0p} = 1\%$ ,  $k_{3p} = 5\%$ ,  $s = 0.1$ ,  $d_0 = 0.05$ .

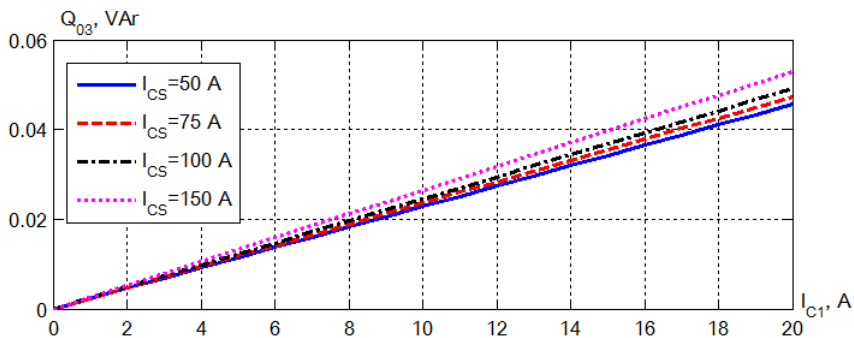

**Fig. 7.** Dependencies of the asymmetry reactive power  $Q_{031}$  for the third harmonics as a function of the capacitive current of the line  $I_{C1}$  for several  $I_{CS}$  values.

The asymmetry reactive power of the line  $Q_{031}$  depends, as has already been shown for several harmonics, on the difference between the maximum capacitance deviations of the line  $\Delta C_{01p}$  and the network  $\Delta C_{0p}$ , as well from the share of the third harmonic in the supply voltage  $k_{3p}$ . Dependencies of this type are shown in Figure 8. They were obtained in a system with the following parameters:  $I_{CS} = 100$  A,  $I_{C1} = 5$  A,  $\Delta C_{0p} = 1\%$ ,  $s = 0.1$ ,  $d_0 = 0.05$ . The bigger difference  $|\Delta C_{01p}| - |\Delta C_{0p}|$  and the higher value  $k_{3p}$ , the higher the asymmetry power is.

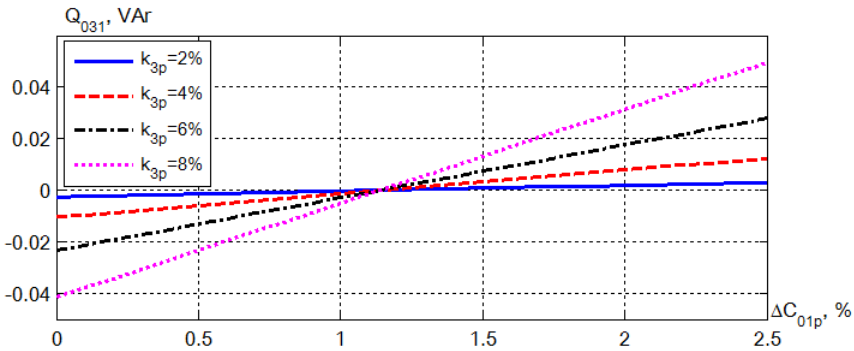

**Fig. 8.** Dependencies of the asymmetry reactive power  $Q_{0h}$  vs. the maximum capacitance deviation of the line for a few percentage values of the harmonic content in the supply voltage  $k_{hp}$ .

Reactive power of the line  $Q_{031}$  practically does not depend on the degree of a compensation detuning  $s$  in a wide range of changes of this parameter. This is evidenced by the characteristics shown in Figure 9, which were obtained in a system with the following parameters:  $I_{CS} = 100$  A,  $I_{C1} = 5$  A,  $\Delta C_{0p} = 1\%$ ,  $\Delta C_{01p} = 2\%$ ,  $k_{3p} = 5\%$ ,  $d_0 = 0.05$ . The value of power in a case of exact compensation ( $s = 0$ ) is very similar to the value corresponding to the network with an isolated neutral point ( $s = -1$ ). The parameter  $s$  is inessential in determining the asymmetry reactive power for the third harmonics of current and voltage.

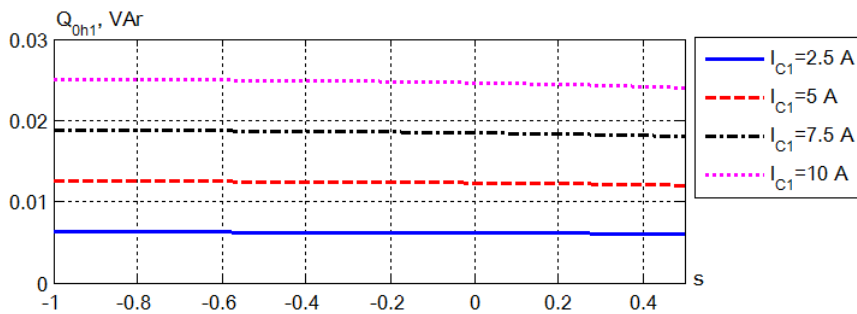

**Fig. 9.** Dependencies of the asymmetry reactive power  $Q_{0h1}$  vs. the compensation detuning  $s$  for several capacitive current values of the line  $I_{C1}$ .

## 4 Conclusions

Detection of high-resistance short-circuits in compensated medium-voltage networks is a topical and important problem due to the ineffectiveness of traditional earth-fault protections. In order to solve this problem, new, more effective, methods of detection of short circuits are sought. The method based on the use of the reactive power criterion  $Q_{0h}$  of



higher harmonics of zero sequence current and voltage generated by the non-linear resistance  $R_F$  in a short-circuit is promising in terms of detection of high resistance faults. Preliminary tests have shown [4, 5] that in symmetric networks can detect short circuits with resistance  $R_F > 100 \text{ k}\Omega$  using this criterion.

In real networks, there is always a small asymmetry of phase-to-earth capacitances, and in supply voltages there are higher harmonics generated by non-linear loads. The undesirable effects of these phenomena in the network are the asymmetry currents, voltages and powers of higher harmonics.

To ensure correct operation of the protection using the reactive power criterion for higher harmonics, it is necessary to determine the setting power  $Q_{0hset}$ , which should be higher than the maximum expected asymmetry power. For this purpose, extensive tests of zero sequence currents and voltages for harmonics and corresponding reactive power have been carried out in a 15 kV compensated network as a function of all relevant parameters, i.e.: maximum capacitance deviation of the network  $\Delta C_{0p}$  and protected line  $\Delta C_{01p}$ , percentage content of harmonics in supply voltages  $k_{hp}$ , capacitive current of the network  $I_{CS}$  and the line  $I_{C1}$ . As a result of the research it was stated:

- The asymmetry power in the protected line  $Q_{0h1}$  for harmonics appears in case of the asymmetry of the network and the line capacitances ( $\Delta C_{0p} \neq 0$ ,  $\Delta C_{01p} \neq 0$ ). Its value and sign depend on the difference  $\Delta C_{01p} - \Delta C_{0p}$ . A positive value of  $Q_{0h1}$ , limiting the protection setting, appears when the maximum deviations of the line and network capacities are the same sign and when the difference between their absolute values is greater than zero  $|\Delta C_{01p}| - |\Delta C_{0p}| > 0$ . Power  $Q_{0h1}$  increases proportionally to the difference  $|\Delta C_{01p}| - |\Delta C_{0p}|$ , harmonic content  $k_{hp}$ , capacitive current of the line  $I_{C1}$  and increases non-linear versus frequency. The reactive power of the line depends only slightly on the capacitive current of the network  $I_{CS}$  and is practically independent of the degree of compensation detuning  $s$ .

- Voltage and current components for the third harmonic are best suited for practical use, since the asymmetry power of these components  $Q_{031}$  is the smallest among the considered harmonics and the settings of the protection will be the smallest.

- From the attached characteristics, in the worst case scenario that can occur in the real network ( $I_{CS} = 100 \text{ A}$ ,  $\Delta C_{0p} = 1\%$ ,  $\Delta C_{01p} = 2.5\%$ ) with extremely high content of the third harmonic  $k_{3p} = 5\%$ , the asymmetry reactive power  $Q_{031}$  does not exceed 25 mVAR. With such a threshold, the protection using the reactive power criterion  $Q_{031}$  is able to detect earth faults with very high non-linear resistance  $R_F$ , reaching up to several tens k $\Omega$ , as shown in publications [4, 5].

- To ensure a sensitive protection setting, it is necessary to know many detailed network parameters, in particular:  $\Delta C_{0p}$ ,  $\Delta C_{01p}$ ,  $k_{3p}$ ,  $I_{C1}$  and  $I_{CS}$ . In this case, the asymmetry power, necessary to determine the setting, can be read directly from the attached drawings or determined by interpolation.

## References

1. S. Hänninen, *Single phase earth faults in high impedance grounded networks. Characteristics, indication and location*, Technical Research Centre of Finland, Espoo (2001)
2. J. Lorenc, *Admittance earth fault protection*, Wydawnictwo Politechniki Poznańskiej, Poznań (2007), (in Polish)
3. M. Łukowicz, *Methods of high impedance fault detection in overhead electric power lines*, Scientific Papers of the Institute of Electric Power Engineering of the Wrocław University of Technology, No 99, Monographs No 32, (2013), (in Polish)

4. L. Marciniak, M. Piątek, *Identification of high-resistance earth faults in medium voltage networks using higher harmonics*, *Acta Energetica*, **1**, 50-57, (2017)
5. L. Marciniak, M. Piątek, *Detection of high resistance earth faults in medium voltage networks using higher harmonics*, *Electric Power Engineering (EPE)*, 2017 18<sup>th</sup> International Scientific Conference, 17-19 May 2017
6. L. Marciniak, M. Piątek, *Harmonics generated by nonlinear earth fault resistance in medium voltage networks*, *Zeszyty naukowe wydziału Elektrotechniki i Automatyki Politechniki Gdańskiej*, **53**, 45-48, (2017), (in Polish)
7. K. Musierowicz, *Unconventional methods of fault's detection in electric power systems*, *Przegląd Elektrotechniczny*, **6**, 555-559, (2004), (in Polish)
8. N. I. Elkalashy, M. Lehtonen, *Advancing DWT-Bayesian technique for earth fault protection in MV networks*, *The Online Journal on Electronics and Electrical Engineering (OJEEE)*, **1/2**, 89-93, (2009)
9. L. Marciniak, *Impulse-current and wavelet criteria of resistive and arc earth fault identification in the medium voltage networks*, *Wydawnictwo Politechniki Częstochowskiej, Monographs No 273*, (2013), (in Polish)
10. L. Marciniak, *Wavelet criteria for identification of arc intermittent faults in medium voltage networks*, *Proceedings of the International Symposium "Modern Electric Power Systems MEPS'10"*, paper 09.1, Wrocław, 20-22 September, (2010)
11. J. Lorenc, B. Staszak, *Modeling of phenomena causing asymmetry of earth faults in MV networks*, *Poznan University of Technology Academic Journals*, **86**, 117-127, (2016), (in Polish)
12. PN-EN 50160:2010P. *Voltage characteristics of electricity supplied by public electricity networks*
13. L. Marciniak, *Model of the arc earth-fault for medium voltage networks*, *Central European Journal of Engineering*, **1/2**, 168-173, (2011)
14. A. Sawicki, M. Haltof, *Nonlinear mathematical models of the electric arc*, *Przegląd Elektrotechniczny*, **92/11**, 257-261, (2016), (in Polish)
15. A. Sawicki, *Rationalizations of hybrid electrical arc models*, *Przegląd Elektrotechniczny*, **93/11**, 198-203, (2017), (in Polish)
16. Sawicki A., Haltof M., *Spectral and integral methods of determining parameters in selected electric arc models with a forced sinusoid current circuit*. *Archives of Electrical Engineering*, **65/1**, 87-103, (2016)