

Monitoring of the stability of underground workings in Polish copper mines conditions

Krzysztof Fuławka^{1,*}, Piotr Mertuszka¹ and Witold Pytel²

¹KGHM CUPRUM Ltd. Research and Development Centre, 2-8 Gen. Sikorskiego St., 53-659 Wrocław, Poland

²Wrocław University of Science and Technology, Faculty of Geoengineering, Mining and Geology, 27 Wyb. Wyspińskiego St., 50-370 Wrocław, Poland

Abstract. One of the problems associated with the excavation of deposit in underground mines is the local disturbance in a state of unstable equilibrium results in the sudden release of energy, mainly in the form of roof falls. The scale and intensity of this type of events depends on a number of factors. To minimize the risk of instability occurrence, continuous observations of the roof strata condition are recommended. Different roof strata observation methods used in the Polish copper mines have been analysed within the framework of presented paper. In addition, selected prospective methods, which could significantly increase efficiency of rock fall prevention are presented.

1 Introduction

Natural hazards associated with the underground exploitation of copper ore deposit are ranked among the most serious threats in the mines belonging to KGHM Polska Miedź S.A. The largest risk for the mining operation are created by seismic activity with their potential effects such as rockbursts or roof falls. In addition, the increasing surface of mined out areas causes a local disturbance in a state of unstable equilibrium, which may lead to rock migration towards the working. The level and intensity of this phenomena depends on a number of factors, the most important of which are [1]:

- depth of mining,
- geometry of the mining drifts,
- distance to the disturbed zones,
- proximity to mined out areas,
- physical and mechanical properties of the surrounding rocks,
- applied support,
- presence of tectonic disturbances, etc.

The economic aspect should be also considered, since the instability occurrence may result in machinery and underground infrastructure damage and consequently lead to stoppages of mining operations. The greatest difficulties with the roof control are observed in the vicinity of the exploitation front, where the highest deformations occur [2]. Monitoring of the condition of workings in Polish underground mines is conducted in a very wide range [3,4]. Different types of observations and measurements covering all mining districts are carried out by specialized mining services in accordance with the internal guidelines.

* Corresponding author: kfulawka@cuprum.wroc.pl

This study reviews the current observation methods of underground workings stability and presents selected prospective methods that can significantly improve the safety of work in Polish copper mines.

2 Current state of safety in the context of instability risk

Most of currently applied observations of the immediate roof strata cannot trigger any alert prior to the event occurrence. This means, that the crew is not always informed of the emergency. This situation significantly affects the accident rates in underground mining. Figure 1 summarizes the number of accidents in KGHM’s mines that occurred between 2010 and 2016, including fatal and serious accidents.

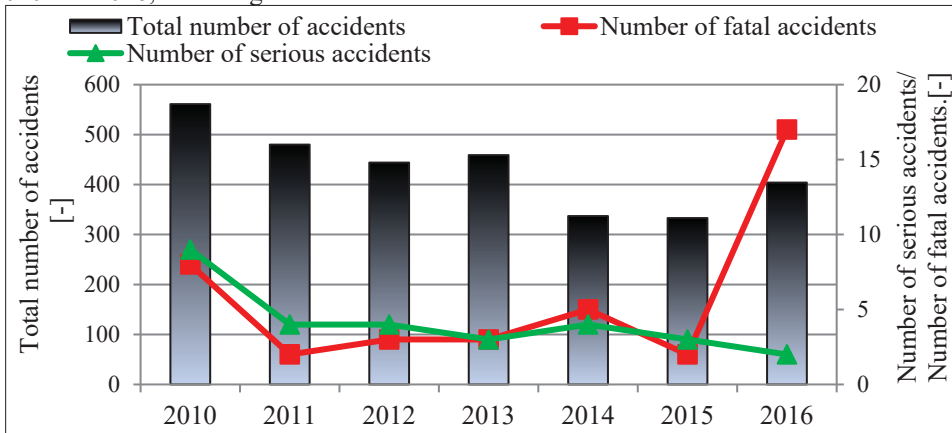

Fig. 1. Number of accidents in Polish copper mines between 2010 and 2016.

In 2016, the number of fatal accidents dramatically increased compared to the previous year. Fourteen of the seventeen fatalities were caused by roof falls and rockbursts. Those events were also the cause of two serious and 49 light injuries (see Fig. 2). It is worth highlighting that these statistics refer only to the incidents, the consequences of which were fatal, serious or collective accidents. In fact, the number of light accidents caused by falling rocks can be much higher, since they are reported as "caused by other factors", so their exact number is difficult to determine.

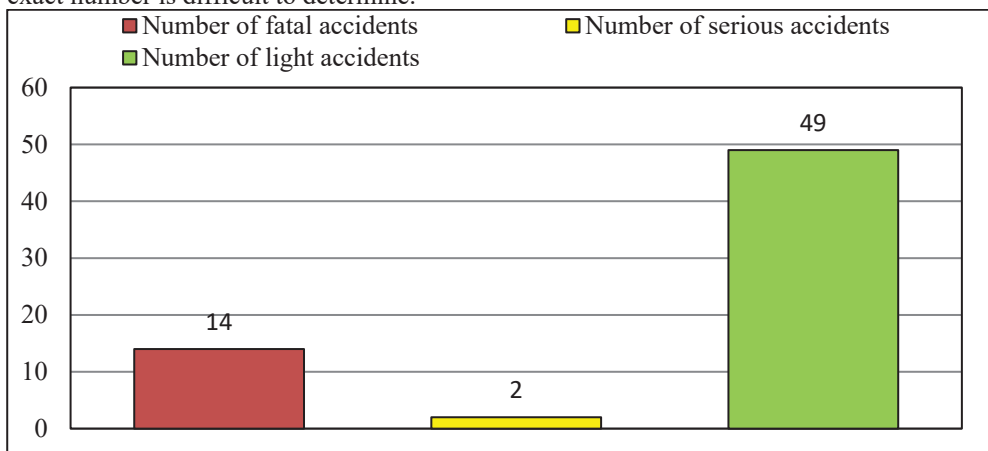

Fig. 2. Number of people injured in accidents caused by roof falls and rockbursts in KGHM’s mines in 2016 (based on [6])

3 A review of observation methods of mine workings used in KGHM's mines

Apart from technical solutions of the roof falls prevention (see Fig. 3), observations of the current condition of the excavations are required.

Roof fall hazard and its consequences severity are mitigated by the following safety measures:

- bed separation gauges installed at all crossing of production excavations,
- endoscopic examination within boreholes in immediate roof strata
- identifying of fissures, bedding planes, and other important characteristics of rock mass,
- verification of the tightening torque, bearing capacity measurements,
- analysis of drill holes deformation using different sensors,
- measurements of convergence of mine workings.

In addition, the following visual observation are carried out:

- monitoring of vertical cracks within the immediate roof strata,
- bolt plates' deformation inspection,
- breaking of timber posts,
- survey of artificial support individual elements performance.

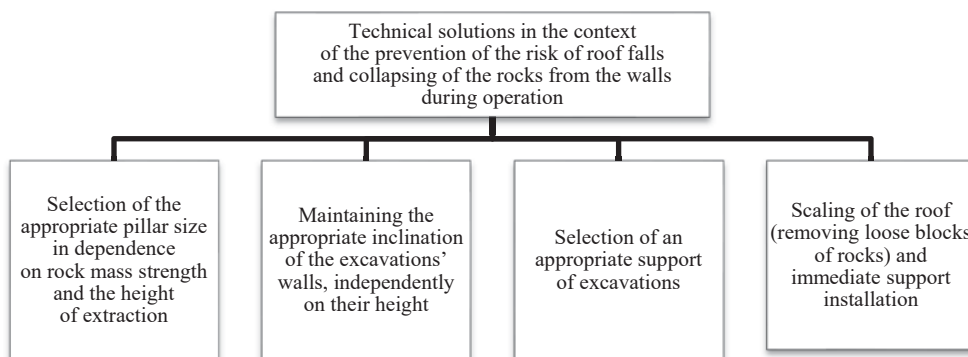

Fig. 3. Technical solutions of roof falls prevention applied in Polish copper mines.

3.1 Observations of bed separation within the immediate roof strata

Roof bed separation gauges called SRS are installed at all crossings of production excavations. It is primary tool for regular observation of the roof stability. Roof bed separation gauges are available in both mechanical and electronic versions [5]. Due to the ease of installation, mechanical gauges are the most commonly used in Polish copper ore mines. They are usually installed using a single resin cartridge. Their length depends on the height of the opening and the length of the rock bolts used. Generally, the length of the SRS sensor's rod ranges from 3 to over 7 meters. It is assumed that the depth of installation of this type of a sensor should be equal to double length of the regular support. This allows to install SRS sensors above the weak layers of immediate roof. These sensors are manufactured in several variants, which differ in the number of signalling plates, their thickness and shape. The most common, however, is a five-plate sensor with a single plate's thickness of 5 mm, what is presented on Fig. 4.

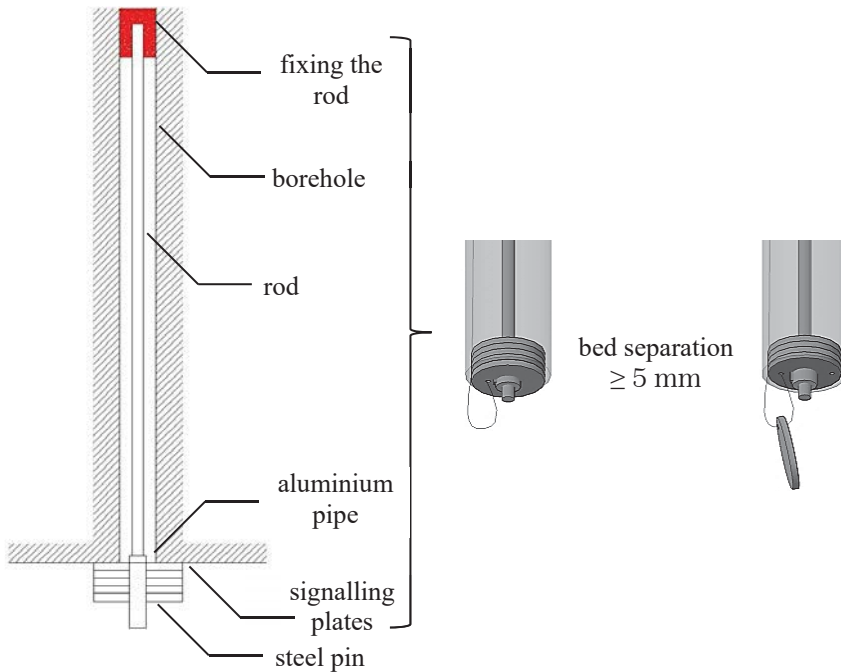

Fig. 4. Principle of operation of the bed separation gauges (based on [7]).

The many advantages of this method include the ease of results interpretation. As the stratification of the rocks in the roof progresses (above 5 mm), the first plate is being squeezed through the steel pin and hangs on the safety rope (see Fig. 4). The falling of the subsequent plates indicates the progressing of stratification process: 10÷15 mm (2 plates); 15÷20 mm (3 plates); 20÷25 mm (4 plates) and above 25 mm (5 plates).

SRS gauges, despite their many advantages, do not provide information about the scale of the hazard. This means that identification of the exact location of bed separation due to excessive shearing is impossible. Another disadvantage of this type of signalling device is the high probability of damage due to mining operations, e.g. as a result of a loop breaking, on which the signalling plates should hang.

More detailed information on the condition of immediate roof strata can be obtained by application of electrical extensometers. Currently, several variants of this type of sensors are used, including:

- multi point cable extensometers,
- CRN-type extensometers,
- tell-tale type extensometers.

The CRN extensometer (Fig. 5) determines any unstable trends between two anchored points in the roof strata. This system accuracy is 0.03 mm. The idea of measurement using this type of sensor is to determine the displacement of the sliding transducer as a result of the movement of the top and lower anchors. The advantage of this type of sensors is their high durability, which determines their suitability in excavations designed as a long-term use, e.g. functional chambers, workshops etc.

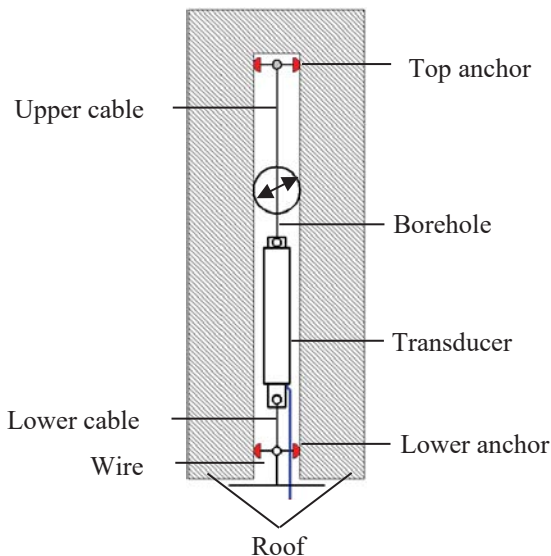

Fig. 5. Scheme of CRN-60 extensometer (based on [2]).

Another type of ground movement sensor used in Polish copper mines is flexible sonic probe extensometer (Fig. 6), which are used to measure displacements and horizons of strata. It allows for location of bed separation that occurs along the borehole, typically around 7.0 m.

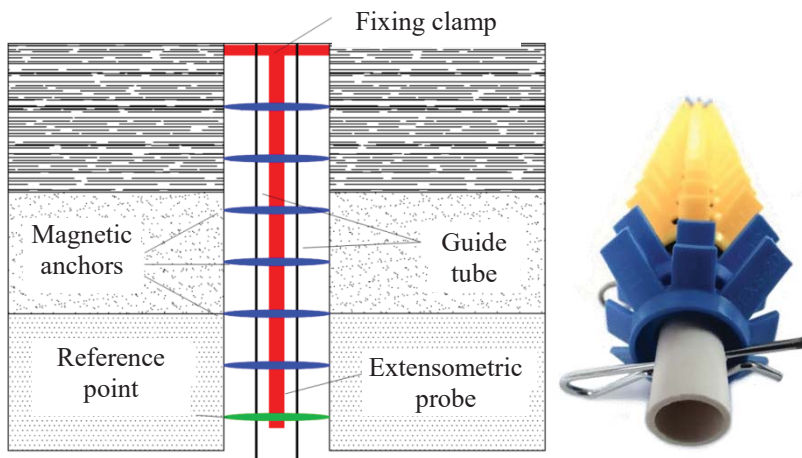

Fig. 6. Principle of operation of sonic probe extensometer [8]

3.2 Measurements of convergence in underground excavations

Convergence measurement is one of the simplest and most common methods of monitoring the underground workings. The concept of convergence refers to the reduction of workings cross-section, which may be vertical (the height of the working reduces) or horizontal (the width of the working reduces). In general, horizontal convergence is many times smaller than convergence in the vertical direction, therefore in practice, vertical convergence measurements are mostly used [9-11]. The main objective of the convergence monitoring is to locate the areas of increased stress generated by mining operations or geology [12]. The results of such measurements are therefore crucial in the assessment of geomechanical

hazards in underground mines and are often the basis for determining the working life of the given mining drift [13, 14]. A number of different types of convergence meters are currently available, but the principle of operation in all types is similar. In general, convergence sensors are permanently fixed between the roof and the floor. They consist of two coaxial sleeves (Fig. 7) of different diameters. One of sleeve moves inside the other. In addition, the inner sleeve is fitted with a millimetre scale that allows the distance between the roof and the floor of the working to be read.

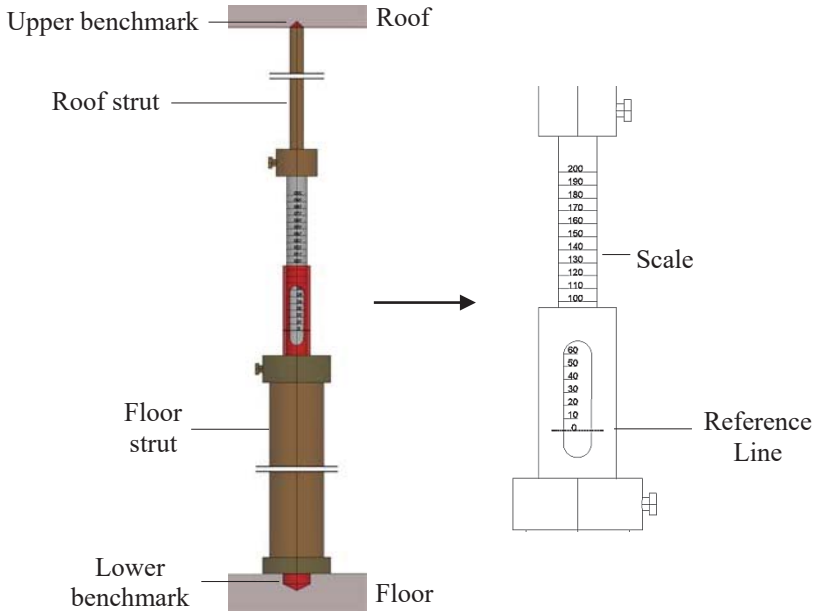

Fig. 7. Scheme of a telescopic convergence indicator [7].

The basic disadvantage of this type of measurement is the low reading frequency and accuracy of the results obtained. It is assumed that the readings are carried out once a day, most often on the first shift. Finally, it is difficult to determine an alarm condition caused, for example, by a sudden increase in convergence on the three preceding shifts.

3.3 Visual observations of boreholes

Irrespective of the applied mining method, excavation of the rock mass generates the cracks with a range, which is usually larger than the size of the working [15]. Observations of the cracked zone within the roof strata in KGHM mines are conducted mainly in areas of increased exploitation pressures by the use of borehole endoscope or infrared camera [16]. The optical endoscope is composed of several tubular elements with optical circuits. The principles of roof control using the borehole endoscope is shown in Figure 8.

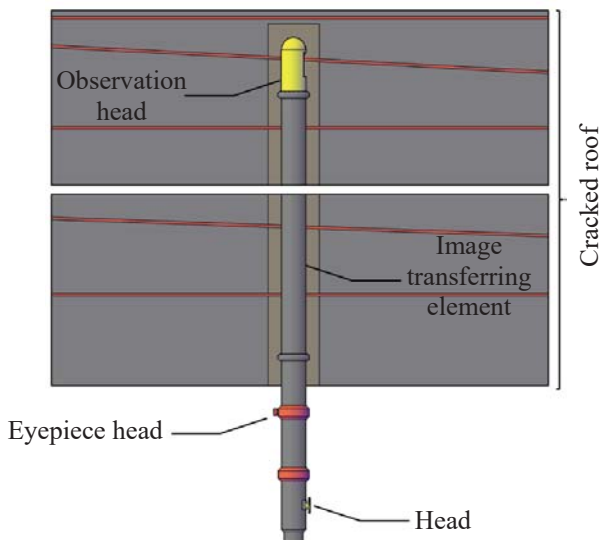

Fig. 8. Diagram of a borehole endoscope [7].

Endoscopic studies provide information on the range of the cracked zones and their distribution within the observation hole [17]. This information may be used at the roof support selection stage [18]. It should be noted, however, that despite the valuable data about the condition of the roof, such measurements are not often carried out. This method is both cumbersome and time-consuming. In general, roof observation using the borehole endoscope is carried out at all intersections of mining drifts on which the bed separation gauges have already signalled the roof fall hazard.

3.4 Measurements of borehole deformation

The analysis of borehole deformation can be carried out using different types of sensors. Currently in KGHM's mine, two types of sensors are used, i.e. DDN (Diameter – Diameter) and DLN (Diameter – Length) sensors, allowing to track the changes of hole diameter and changes of the distance between two points anchored in axis of the drill hole [19]. Sudden changes in diameter or length of inspected hole will follow the alert to take preventive actions. These sensors can be used to monitor the condition of the roof and to observe the transition of the pillars into the post-critical phase (Fig. 9) [20]. It is generally recommended that DD sensors should be applied in vertical holes. This is caused by the lack of sensitivity to delamination in the roof layers associated with the separation of thin rock layers. DL-type sensors, in turn, should be used in horizontal holes, because deformations in the walls and pillars are mainly vertical, which is directly related to the phenomenon of pillar's compression.

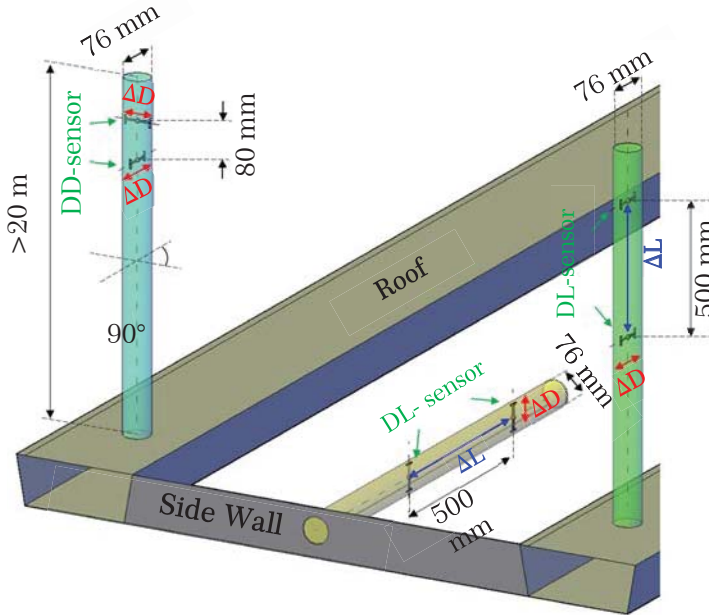

Fig. 9. Application of borehole deformation sensors.

3.5. Measurement of anchor tensioning

Among the many methods used to assess the condition of the rock mass, the tests of the load-bearing capacity of the rock bolts (Fig. 10) are performed. Checking the torque tensioning of the rock bolt indicates the degree of fastening of the roof layers. Mechanical expansive shell bolts should have a tensioning torque of at least 250 Nm, while grouted rock bolts should have 150 Nm [1].

The rock bolt pull-out test procedure is following: after installation, the rock bolt is loaded with the static tensile strength generated by the hydraulic cylinder, gradually increasing until it is ripped out from the hole. The maximum amount of tensile force measured at failure is considered as a parameter of the rock-bolt load bearing capacity. Unlike laboratory tests, underground tests do not raise any significant objections to the required stiffness of the measuring system. This type of tests represents rather static and slow physical processes in the rock mass associated with the progress of mining works or excavation of deposits in adjacent mining parcels and processes of squeezing when we are dealing with inelastic-plastic type of rocks walls.

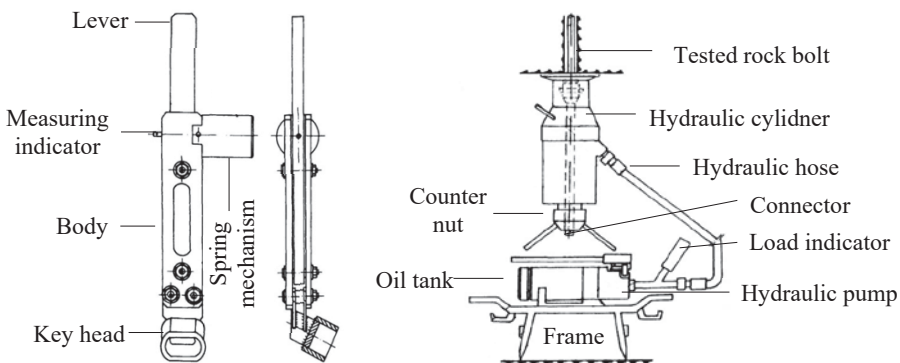

Fig. 10. Diagram of torque wrench (left) and hydraulic dynamometer (right) [7].

4 Prospective methods of monitoring of mine workings conditions

All of the above-mentioned monitoring methods, beside SRS bed separation gauges, have one common disadvantage - they do not automatically alert the crew of the possible hazard. Moreover, presented methods do not allow for continuous analysis of the data collected due to low frequency of measurements. The amount and quality of collected information and data is essential in contemporary monitoring [20]. Properly selected frequency and resolution of measurements are the basis of appropriate assessment of the rock mass condition, what can be directly translated into the crew's safety (alerting of the possible instability) and measurable financial benefits. Therefore, it seems important to undertake additional actions aimed at improvement of the existing monitoring systems, e.g. by implementing new and more advanced measuring tools, which can lead to the minimization or elimination of the most common error, i.e. human error. The following part of the study presented selected innovative systems of monitoring of underground workings.

4.1 Measurements of mine workings inclination

Inclinometric measurements allow to determine the angle of inclination of all elements of the geomechanical system, i.e. floor, roof and pillars [21]. Measurements are carried out using a special devices that consists of inclination sensor(s) and a communications terminal (Fig. 11). This type of measurements is characterized by high resolution and quasi-continuous character (frequency ≥ 1 sample per 1 min). Data are collected from two perpendicular directions X and Y, what allows to determine the resultant direction of deformation [22].



Fig. 11. Components of inclinometric measurements system: communication terminal (left) and a CNS sensor (right).

The measurements of the changes of inclination angle of roof, floor or walls may be useful for the local assessment of mining drifts stability and for monitoring of the rock mass deformation. The CNS sensor is equipped with a signalling diode, which inform, that the threshold values of the inclination angle have been exceeded. Communication with the CNS sensor is done wirelessly. Previous experiences of the application of inclinometric

measurements indicate that it is a very useful tool for the stability assessment of the roof stratum and for tracking of large scale deformation. Example of data gathered with inclinometric measurements system is shown on Fig. 12.

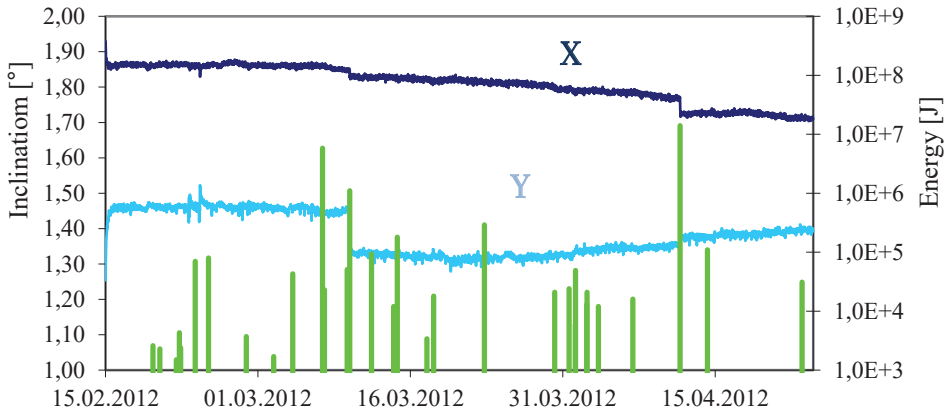

Fig. 12. Changes of the roof inclination in time.

4.2 Spatial laser scanning

The convergence monitoring described in Section 3.2 are point-based measurements, which directly translates into the assessment of the hazard level in the given mining parcels. Detailed information on the convergence of mine workings can be obtained by the use of laser scanners. Laser scanning technology has already been used successfully in the open-pit mining industry. Application of this method in the monitoring of underground workings conditions is still being developed.

In 2016, laser scanning technology of underground excavations was tested in one of the mine belonging to KGHM. As a result, two-dimensional models describing the convergence process and a spatial model of the whole mining division were obtained (Fig. 13).

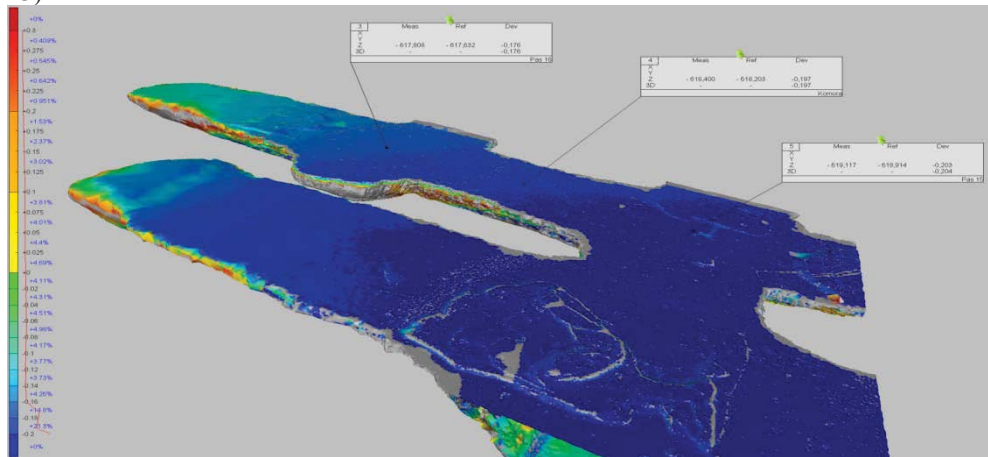

Fig. 13. Spatial model of mine workings generated using laser scanning [23].

The major disadvantage of this type of measurement is the disturbance of the mining process within mining parcel being measured. Obviously, during the scanning of workings, any movement of machinery is highly unwanted. However, a regular laser scanner allows

for precise determination of the deformations and displacements of the mine workings. This information may be useful while generating the model of rock mass behaviour subjected to changes due to mining operations.

4.3 Instrumented rock bolts

Observations of engineering structures using instrumented rock bolts have been carried out for many years, but so far, they have not been widely used in the Polish copper ore mining industry. The most popular are the rock bolts equipped with strain gauges [24, 25], but they are also available with fibre optic sensors [26]. Unfortunately, the solutions used so far in the Polish copper ore mining industry did not meet the requirements of measurement accuracy and sampling frequency. In addition, it was impossible to perform the long-term measurements without external power supply. In 2016, KGHM CUPRUM collected and tested the equipment dedicated for the observations of immediate roof strata. The pilot stress measurements were performed using a four-groove bolt with a highly-advanced data collecting system. The rock bolt used allowed for the stress measurements on five levels of the bolt along four orthogonal directions. The four-way system allowed for a full tracking of the stresses acting vertically and in horizontal directions [27] (Fig. 14). Moreover, the continuous recording may be conducted at a frequency adjusted to the requirements of the user. During the pilot underground tests, stress changes were recorded at a frequency of 1 Hz. The operating time of one battery lasted 2 months. Reducement of the sampling rate allows for extension of the operating time). Another important feature is also the autonomous nature of the data collection system.

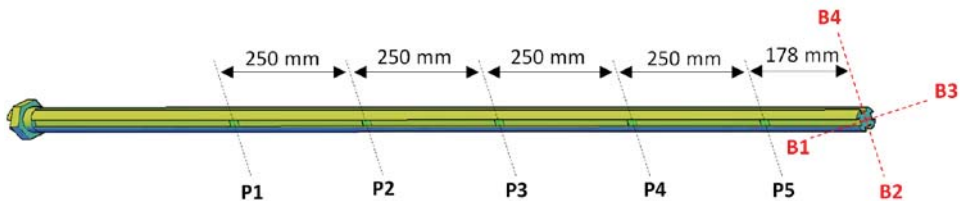

Fig. 14. General view of the instrumented rock bolts (based on [27]).

Measurements using electrical resistance strain gauges are based on the increase or decrease of conductor resistance as a result of a change in cross-sectional area due to tension or compression. Installation of the instrumented rock bolt itself does not differ from the standard bolt installation. The recorder with battery should be placed in cylindrical borehole next to the rock bolt (Fig. 15).

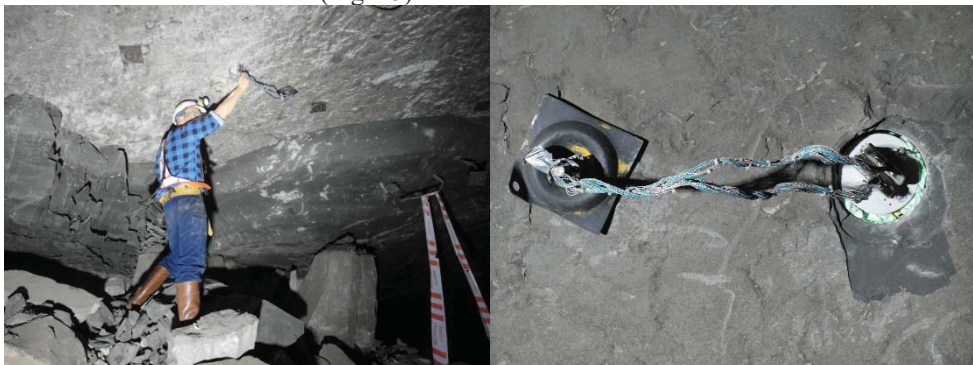

Fig. 15. Installation of instrumented rock bolt.

The results of the measurements confirmed the validity of the use of this type of instruments for the monitoring of underground workings. The location of the strain gauges in four vertical grooves allows for the axial and shear stresses determination. Rapid increase in one of these values indicates that the instability may occur. In addition, determination of the scale of hazard and, therefore, indication of the height at which instability has occurred or will occur may be reached by the application of few measuring levels. Based on measured values, the following parameters may be determined:

- displacements,
- bending moments,
- axial stresses,
- shear stresses,
- von Misses stresses

on each measuring level (Fig. 16).

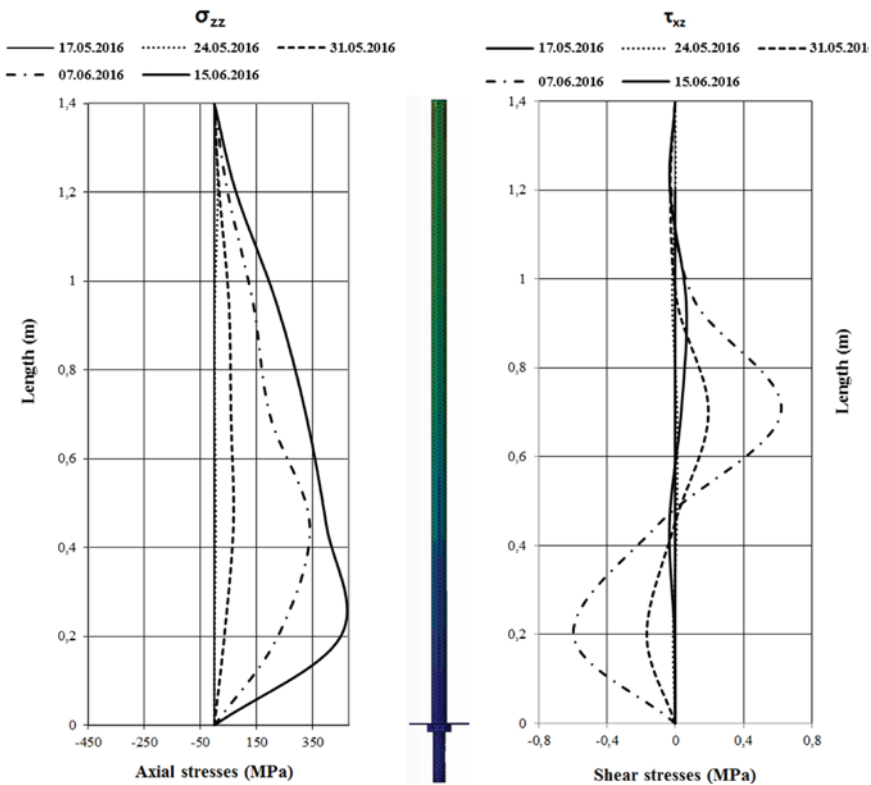

Fig. 16. Distribution of axial stresses (left) and shear stresses (right) on different measuring levels.

5 Summary

The stability of underground workings in Polish copper ore mines is monitored using a number of measuring instruments. These tools have relatively simple construction, however allow for the quick assessment of the current state of the rock mass in the area of existing mining drifts. Despite the obvious advantages, currently used instruments do not allow for a comprehensive assessment of the scale of the hazard, what is limited due to obsolete technology, which requires involving additional personnel. Bearing in mind, that the exploitation of the flat copper ore deposits in KGHM's mines is conducted in relatively

difficult mining and geological conditions, new technological solutions for the observation of rock mass behaviour subjected to both static and dynamic loading should be considered. The current knowledge on applicable mining methods and access to advanced measuring devices should result in the introduction of newer and more effective observation technologies, that will be able to inform on the level of local hazards as soon as safety thresholds are exceeded. An appropriate interpretation of the collected data, in turn, will allow a detailed analysis of the rock mass state in the vicinity of active mining parcels prior to the roof fall or rockburst occurrence.

The perspective observation methods described within the framework of this paper will provide precise information on the rock mass behaviour during mining operations within given mining parcel, which in the longer term may contribute to the implementation of more effective preventive measures, what was confirmed by the results of performed measurements. Inclinometric measurements conducted in the vicinity of exploitation front enable evaluation of the behaviour of all elements of the geomechanical system. i.e. roof, floor and walls. On the other hand, laser scanning at regular time intervals shall produce the deformation profile throughout entire mine workings, which may allow to identify zones that are prone to instability. The basic purpose of monitoring of the rock mass behaviour using the instrumented rock bolts is to determine the scale of movement in the horizontal and vertical direction of the roof and floor stratum around the yielding pillar. When considering the roof fall hazard, instrumented rock bolt seems to be most suited to mining and geological conditions in KGHM's mines. Alerting on the increased risk of the occurrence of instability followed by a critical condition of the rock mass gives an opportunity to take appropriate preventive measures.

This work was financed by the Grant no. 0401/0128/17.

References

1. W. Pytel, *Geomechanical problems of the selection of mining excavation casing* (Wyd. KGHM CUPRUM, Wrocław 2012)
2. J. Butra, R. Dębowski., D. Pawelus, M. Szpak, *Cuprum*, no. **58**, 43-71 (2011)
3. T. Majcherczyk, P. Małkowski, *Górnictwo i Geoinżynieria*, no. **29** z. 3/2, 61-76 (2005)
4. G. Mutke, W. Masny., S. Prusek, *Acta Geodynamica et Geomaterialia*, Vol. **13**, No. 4 (184), 367-378 (2016)
5. C. Matusz, K. Szczerbiński, *Cuprum* no. **66**, 33-44 (2013)
6. website www.wug.gov.pl
7. *Monograph of KGHM Polska Miedź S.A.*, Lubin 2007
8. S. Fabich S., W. Pytel., *L. Cuprum* no. **17**, 73-94 (2000)
9. T. Majcherczyk, P. Małkowski, Z. Niedbalski, *Górnictwo i Geoinżynieria*, no. **3/1** (2005)
10. S. Piechota, *Przegląd Górniczy*, no. **12** (2001)
11. P. Małkowski, Z. Niedbalski, T. Majcherczyk, *Górnictwo i Geoinżynieria*, no. **32** (2008)
12. R. Hejmanowski, A. Malinowska, K. d'Obyrn, *Przegląd Górniczy*, vol. **70**, no. 7, 51-55 (2014)
13. E. Hrubešova, Z. Kaláb, R. Kořinek, P. Žůrek, *Kwartalnik UWND AGH, Górnictwo i Geoinżynieria*, no. **3** (2007)

14. T. Majcherczyk, T. Małkowski, Z. Niedbalski, Materiały Zimowej Szkoły Górniczej i Geoinżynierii, Krynica, 509-517 (2006)
15. P. Małkowski, Wiadomości Górnicze, no. **5**, 259-269 (2014)
16. J. Parchanowicz, S. Laskownicki, K. Szczerbiński, Cuprum, no. **19**, 27-32 (2001)
17. P. Małkowski, Kwartalnik AGH Górnictwo i Geoinżynieria, no. **3-4**, Uczelniane Wydawnictwa Naukowo-Dydaktyczne AGH, 419-425 (2003)
18. T. Majcherczyk, P. Małkowski, WUG: Bezpieczeństwo Pracy i Ochrona Środowiska w Górnictwie, no. **2** (2002)
19. S. Orzepowski, J. Butra, Rudy i metale nieżelazne, no. **2** (2011)
20. S. Orzepowski, WUG: Bezpieczeństwo Pracy i Ochrona Środowiska w Górnictwie, no. **9** (2002)
21. W. Grzebyk, L. Stolecki, WUG: Bezpieczeństwo Pracy i Ochrona Środowiska w Górnictwie, no. **8**, 17-22 (2013)
22. W. Grzebyk, L. Stolecki, WARSZTATY 2014 z cyklu: Górnictwo - człowiek - środowisko: zrównoważony rozwój, Mat. Symp., 92-100 (2014)
23. *Detailed project of exploitation in field XIII/4 of G-2 mining district with information about the exploitation progress*, KGHM Polska Miedź S.A., Oddział Zakłady Górnicze „LUBIN” (2016)
24. W. Pytel, K. Szeptun, XXVII Zimowa Szkoła Mechaniki Górniczej, Kraków (2004)
25. T. Majcherczyk, Z. Niedbalski, Ł. Bednarek, Przegląd Górniczy, no. **3**, 41-47 (2014)
26. S. Spearing, *The Precise Monitoring Of Rockbolt Performance Underground Final Technical Report*, Short-Term Innovative And Exploratory Research Project Alpha Foundation For The Improvement Of Mine Safety And Health (2015)
27. W. Pytel, P. Mertuszka, E. Fabiańczyk, K. Fuławka, Wiadomości Górnicze, no. **12**, 654-664 (2016)